

RICOH

Priport

JP1210/1250

Operating Instructions

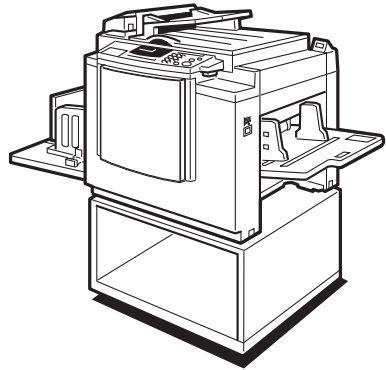

Read this manual carefully before you use this product and keep it handy for future reference.

For safety, please follow the instructions in this manual.



RICOH COMPANY, LTD.

15-5, 1 chome, Minami-Aoyama, Minato-ku, Tokyo
Telephone: Tokyo 3479-3111

Overseas Affiliates

U.S.A.

RICOH CORPORATION
5 Dedrick Place
West Caldwell, New Jersey 07006
Phone: +1-973-882-2000

The Netherlands

RICOH EUROPE B.V.
Groenelaan 3, 1186 AA, Amstelveen
Phone: +31-(0)20-5474111

United Kingdom

RICOH UK LTD.
Ricoh House,
1 Plane Tree Crescent, Feltham,
Middlesex, TW13 7HG
Phone: +44-(0)181-261-4000

Germany

RICOH DEUTSCHLAND GmbH
Mergenthalerallee 38-40,
65760 Eschborn
Phone: +49-(0)6196-9060

France

RICOH FRANCE S.A.
383, Avenue du Général de Gaulle
BP 307-92143 Clamart Cedex
Phone: +33-(0)1-40-94-38-38

Spain

RICOH ESPAÑA S.A.
Avda. Litoral Mar, 12-14,
08005 Barcelona
Phone: +34-(0)93-295-7600

Italy

RICOH ITALIA SpA
Via della Metallurgia 12,
37139 Verona
Phone: +39-045-8181500

Hong Kong

RICOH HONG KONG LTD.
23/F., China Overseas Building,
139, Hennessy Road,
Wan Chai, Hong Kong
Phone: +852-2862-2888

Singapore

RICOH ASIA PACIFIC PTE.LTD.
260 Orchard Road,
#15-01/02 The Heeren,
Singapore 238855
Phone: +65-830-5888

Priport JP1210/1250 Operating Instructions

Printed in The Netherlands

EE (GB) C237-8600

Introduction

This manual contains detailed instructions on the operation and maintenance of this machine. To get maximum versatility from this machine all operators should carefully read and follow the instructions in this manual. Please keep this manual in a handy place near the machine.

Please read the Safety Information before using this machine. It contains important information related to USER SAFETY and PREVENTING EQUIPMENT PROBLEMS.

Notes:

Some illustrations might be slightly different from your machine.

Certain options might not be available in some countries. For details, please contact your local dealer.

Notes:

The model names of the machines do not appear in the following pages. Check the type of your machine before reading this manual.

- LG drum: Not Available
- A4 drum: JP1210
- B4 drum: JP1250

Certain types might not be available in some countries. For details, please contact your local dealer.

Two kinds of size notation are employed in this manual. With this machine refer to the metric version.

For good print quality, Ricoh recommends that you use genuine Ricoh master and ink.

Ricoh shall not be responsible for any damage or expense that might result from the use of parts other than genuine Ricoh parts in your Ricoh office product.

Power Source

220 – 240V, 50/60Hz, 1.3A or more

Please be sure to connect the power cord to a power source as above. For details about power source, see ⇒ P.112 "Power Connection".



Declaration of Conformity

"The Product complies with the requirements of the EMC Directive 89/336/EEC and the Low Voltage Directive 73/23/EEC."

In accordance with IEC 60417, this machine uses the following symbols for the main switch:

I means **POWER ON.**

O means **POWER OFF.**

Safety Information

When using your equipment, the following safety precautions should always be followed.

Safety During Operation

In this manual, the following important symbols are used:

⚠ WARNING:
Indicates a potentially hazardous situation which, if instructions are not followed, could result in death or serious injury.

⚠ CAUTION:
Indicates a potentially hazardous situation which, if instructions are not followed, may result in minor or moderate injury or damage to property.

⚠ WARNING:

- **Connect the power cord directly into a wall outlet and never use an extension cord.**
- **Disconnect the power plug (by pulling the plug, not the cable) if the power cable or plug becomes frayed or otherwise damaged.**
- **To avoid hazardous electric shock, do not remove any covers or screws other than those specified in this manual.**
- **Turn off the power and disconnect the power plug (by pulling the plug, not the cable) if any of the following conditions exists:**
 - **You spill something into the equipment.**
 - **You suspect that your equipment needs service or repair.**
 - **Your equipment's cover has been damaged.**

⚠ CAUTION:

- *Protect the equipment from dampness or wet weather, such as rain, snow, and so on.*
- *Unplug the power cord from the wall outlet before you move the equipment. While moving the equipment, you should take care that the power cord will not be damaged under the equipment.*
- *When you disconnect the power plug from the wall outlet, always pull the plug (not the cable).*
- *Do not allow paper clips, staples, or other small metallic objects to fall inside the equipment.*
- *For environmental reasons, do not dispose of the equipment or expended supply waste at household waste collection points. Disposal can take place at an authorized dealer or at appropriate collection sites.*
- *Be careful not to cut yourself on any sharp edges when you reach inside the machine to remove misfed sheets of paper or masters.*
- *Our products are engineered to meet high standards of quality and functionality, and we recommend that you only use the expendable supplies available at an authorized dealer.*

How to Read this Manual

Symbols

In this manual, the following symbols are used:

 **WARNING:**

This symbol indicates a potentially hazardous situation that might result in death or serious injury when you misuse the machine without following the instructions under this symbol. Be sure to read the instructions, all of which are described in the Safety Information section.

 **CAUTION:**

This symbol indicates a potentially hazardous situation that might result in minor or moderate injury or property damage that does not involve personal injury when you misuse the machine without following the instructions under this symbol. Be sure to read the instructions, all of which are described in the Safety Information section.

* The statements above are notes for your safety.

 **Important**

If this instruction is not followed, paper might be misfed, originals might be damaged, or data might be lost. Be sure to read this.

 **Preparation**

This symbol indicates the prior knowledge or preparations required before operating the machine.

 **Note**

This symbol indicates precautions for operation, or actions to take after misoperation.

 **Limitation**

This symbol indicates numerical limits, functions that cannot be used together, or conditions in which a particular function cannot be used.

 **Reference**

This symbol indicates a reference.

[]

Keys that appear on the machine's display panel.

[]

Keys built into the machine's operation panel.

What You Can Do with this Machine

Below is a quick summary of this machine's features and where to look in this manual for more information

❖ **Standard Printing**

See ⇒ P.5 "Standard Printing".

❖ **Adjusting the Print Image Position**

See ⇒ P.9 "Adjusting the Print Image Position".

❖ **Adjusting the Print Image Density**

See ⇒ P.11 "Adjusting the Print Image Density".

❖ **Halftone Printing**

See ⇒ P.12 "Tint Mode—Halftone Printing".

❖ **Making Clear Prints**

See ⇒ P.13 "Use the **[Fine]** key to make clear prints."

❖ **Changing the Print Speed**

See ⇒ P.14 "Changing the Printing Speed".

❖ **Reducing and Enlarging Using Preset Ratios**

See ⇒ P.16 "Preset Reduce/Enlarge—Reducing and Enlarging Using Preset Ratios".

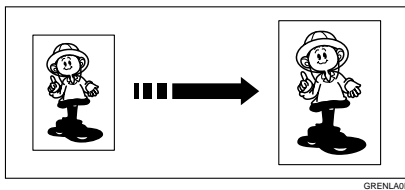
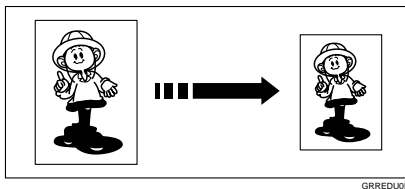

❖ **Erasing Centre and Edge Margins**

See ⇒ P.18 *“Centre/Edge Erase—Erasing centre and Edge Margins”*.

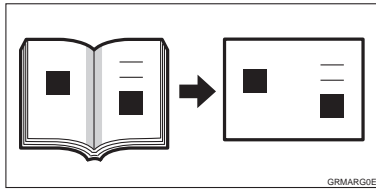

❖ **Erasing Edge Margins**

See ⇒ P.20 *“Edge Erase—Erasing Edge Margins”*.

❖ **Erasing the Shadow of Pasted Originals**

See ⇒ P.22 *“Paste Shadow Erase—Erasing the Shadow of Pasted Originals”*.

❖ **Printing on Thick or Thin Paper**

See ⇒ P.23 *“Printing on Thick or Thin Paper”*.

❖ **Selecting Original Type**

See ⇒ P.24 *“Selecting Original Type”*.

❖ **Saving Ink**

See ⇒ P.25 *“Economy Mode—Saving Ink”*.

❖ **Printing from Several Originals at Once**

See ⇒ P.26 *“Auto Cycle—Printing from Several Originals at Once”*.

❖ **Group Printing from the Same Original**

See ⇒ P.28 *“Class Mode—Group Printing from the Same Original”*.

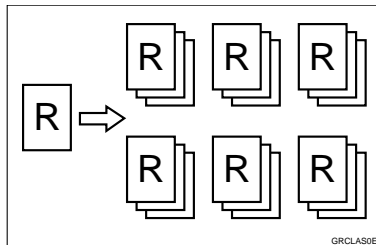

❖ **Group Printing from Different Originals**

See ⇒ P.30 *“Memory Mode—Group Printing from Different Originals”*.

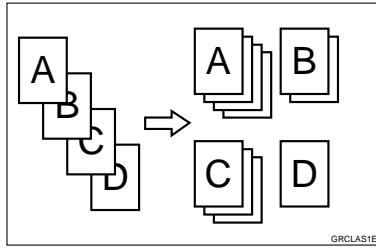

❖ **Combining Originals onto One Print**

See ⇒ P.33 *“Combine—Combining 2 Originals onto One Print”*.

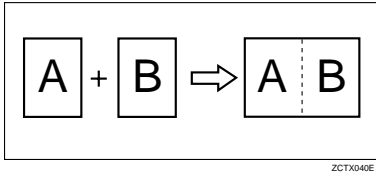
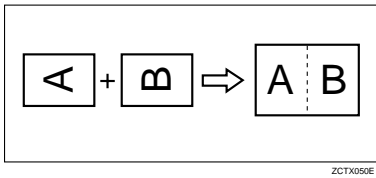

❖ **Skip Feed Printing**

See ⇒ P.37 *“Skip Feed Printing”*.

❖ **Storing Your Print Settings in Memory**

See ⇒ P.38 *“Program—Storing Your Print Settings in Memory”*.

❖ **Printing Secret Documents**

See ⇒ P.42 *“Security Mode—Printing Secret Documents”*.

❖ **Making Colour Prints**

See ⇒ P.52 *“Making Colour Prints”*.

❖ **Printing in Two Colours**

See ⇒ P.54 *“Printing in Two colours”*.

Machine Exterior

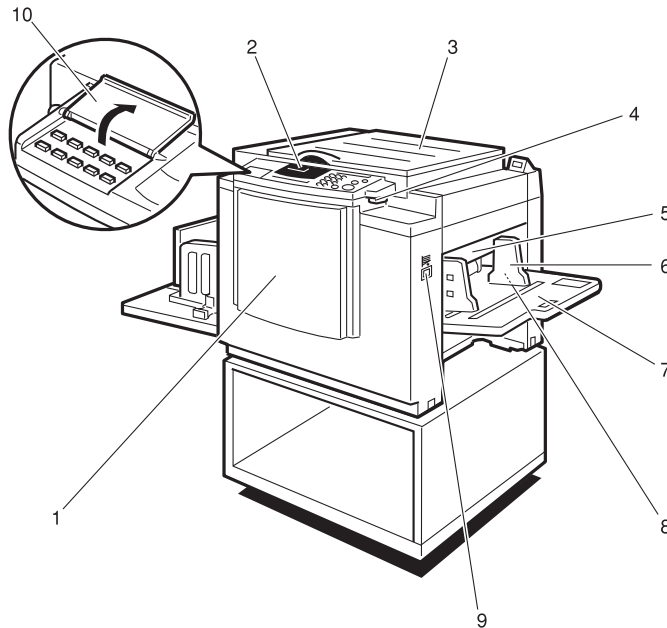

ZC7H020E

1. Front door

Open for access to the inside of the machine.

2. Operation panel

Operator controls and indicators are located here. See ⇒ P.x "Operation Panel".

3. Platen cover

Lower this cover over an original before printing.

4. Original tray release lever

Use to open the original tray unit when installing the master.

5. Feed roller pressure lever

Use to adjust the contact pressure of the paper feed roller according to paper thickness.

6. Paper feed side plates

Use to prevent paper skew.

7. Paper feed tray

Set paper on this tray for printing.

8. Side tray fine adjusting dial

Use to shift the paper feed tray sideways.

9. Paper feed tray down key

Press to lower the paper feed tray.

10. Behind cover

Flip up when you use the keys underneath.

Machine Interior

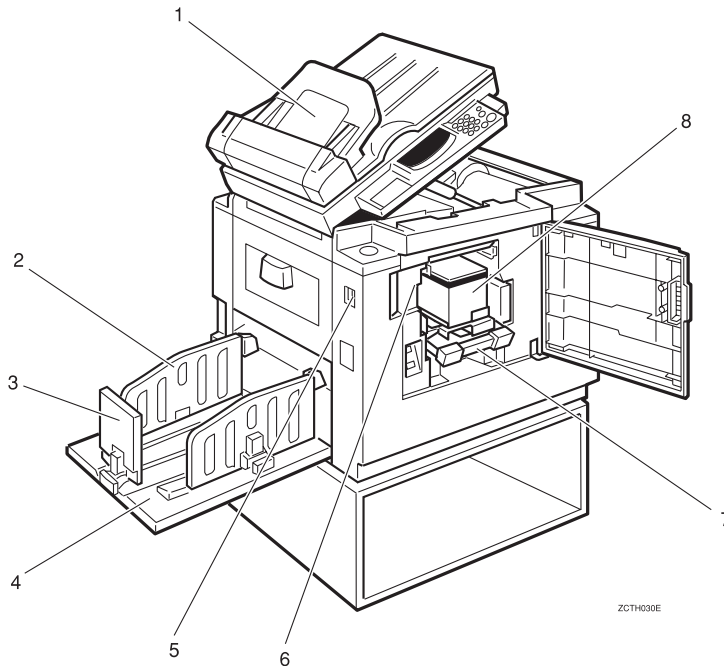

1. Document feeder (Option)

Original inserted into the document feeder are individually and automatically fed onto and removed from the exposure glass. See ⇒ P.43 "Printing Using the Optional 30 Originals Document Feeder".

2. Paper delivery side plates

Use to align the prints on the paper delivery tray.

3. Paper delivery end plate

Use to align the leading edge of prints.

4. Paper delivery tray

Completed prints are delivered here.

5. Main switch

Use to turn the power on or off.

6. Drum unit

The master is wrapped around this unit.

7. Drum unit lock lever

Lift to unlock and pull out the drum unit.

8. Ink holder

Set the ink cartridge in this holder.

Options

◆ 30 Originals document feeder

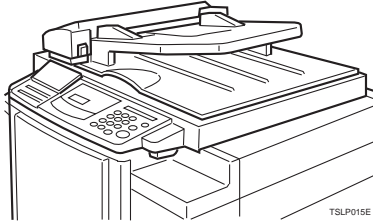

TSLP015E

Note

Other options:

- Colour Drum: LG drum
- Colour Drum: A4 drum
- Colour Drum: B4 drum
- Tape Dispenser
- Key Counter

Operation Panel

Keys

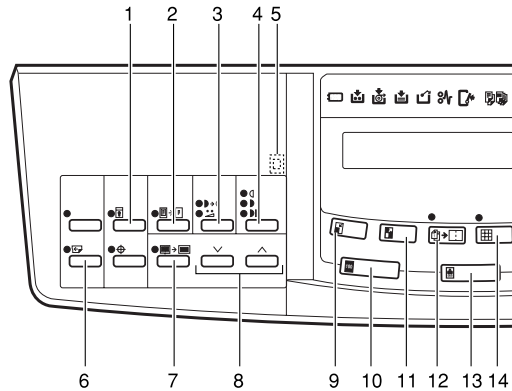

1. **[Security]** key

Press to make prints of secret documents. See ⇒ P.42 "Security Mode—Printing Secret Documents".

2. **[Paste Shadow Erase]** key

Press to erase the shadow of pasted originals. See ⇒ P.22 "Paste Shadow Erase—Erasing the Shadow of Pasted Originals".

3. **[Tint/Economy]** key

Press to make halftone prints. See ⇒ P.12 "Tint Mode—Halftone Printing".

Press to save ink. See ⇒ P.25 "Economy Mode—Saving Ink".

4. **[Image Density]** key

Press to make prints darker or lighter. See ⇒ P.11 "Adjusting the Print Image Density".

5. **Check Indicator**

This indicator lights when you have selected one or more of the functions accessed by lifting the behind cover and pressing the keys underneath (e. g. **[Security]** key, **[Paste Shadow Erase]** key etc.).

This lets you know whether one or more of these functions is selected, even if the cover is lowered.

6. **[Skip Feed]** key

Press to select skip feed printing. See ⇒ P.37 "Skip Feed Printing".

7. **[Center/Edge Erase]** key

Press to print book originals that have a solid image on the centre or edges. See ⇒ P.18 "Centre/Edge Erase—Erasing centre and Edge Margins".

8. **[V] and [^] keys (Scroll keys)**

Press to select size and direction of paper or original in Centre/Edge Erase.

9. **[Reduce]** key

Press to reduce the image. See ⇒ P.16 "Preset Reduce/Enlarge—Reducing and Enlarging Using Preset Ratios".

10. **[Full Size]** key

Press to make full size prints.

11. **[Enlarge]** key

Press to enlarge the image. See ⇒ P.16 "Preset Reduce/Enlarge—Reducing and Enlarging Using Preset Ratios".

12. **[Combine]** key

Press to combine originals onto 1 print. See ⇒ P.33 "Combine—Combining 2 Originals onto One Print".

13. **[Type of Original]** key

Press to select Letter, Photo, or Letter/Photo mode. See ⇒ P.24 "Selecting Original Type".

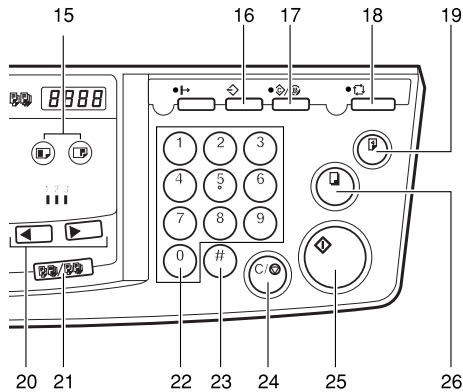

ZCTS010E

14. [Fine] key

Press to select the fine image. See ⇒ P.13 "Fine Mode—Making Clear Prints".

15. [Image Position] key

Press to shift the image forwards or backwards. See ⇒ P.9 "Adjusting the Print Image Position".

16. [Program] key

Press to input or recall user programs. See ⇒ P.38 "Program—Storing Your Print Settings in Memory".

17. [Clear Modes/Energy Saver] key

- Clear Modes
Press to clear the previously entered job settings.
- Energy Saver
Press to switch to and from Energy Saver mode. ⇒ P.8 "Energy Saver Mode — Saving Energy".

18. [Auto Cycle] key

Use to process the master and make prints automatically. See ⇒ P.26 "Auto Cycle—Printing from Several Originals at Once".

19. [Proof] key

Press to make proof prints.

20. [◀] and [▶] keys (Speed keys)

Press to adjust the printing speed. See ⇒ P.14 "Changing the Printing Speed".

21. [Memory/Class] key

Press to select Memory or Class mode. See ⇒ P.28 "Class Mode—Group Printing from the Same Original" or ⇒ P.30 "Memory Mode—Group Printing from Different Originals".

22. Number keys

Press to enter the desired number of prints and data for selected modes.

23. [#] key

Use to enter data in selected modes.

24. [Clear/Stop] key

While entering numbers, press to cancel a number you have entered.

While copying, press to stop copying.

25. [Start] key

Press to make a master.

26. [Print] key

Press to start printing.

Indicators

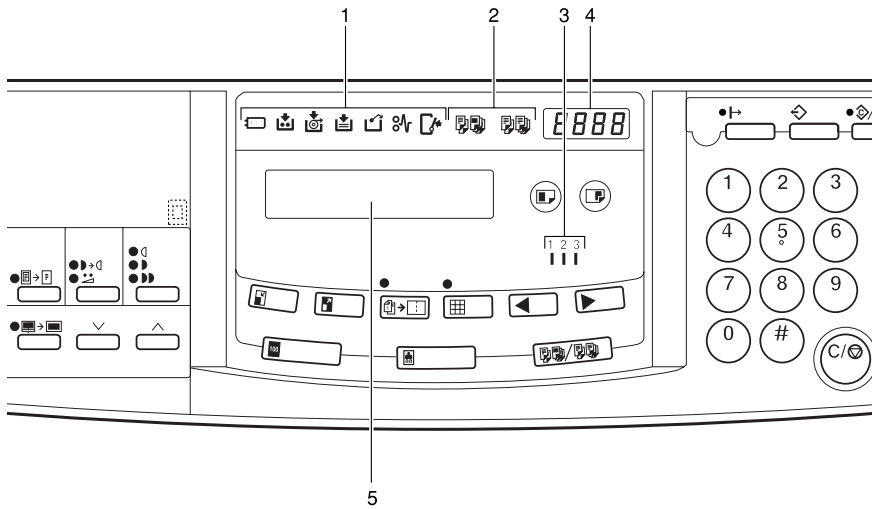

1. Error indicators

These indicators are lit when a non-standard condition occurs within the machine.

2. Memory/Class indicator

Shows the number entered in Memory or Class mode.

3. Speed indicators

These indicators show the printing speed that is selected.

4. Counter

Displays the number of prints entered. While printing, it shows the number of prints remaining.

5. Guidance display

Display the machine's condition.

TABLE OF CONTENTS

1. Operation

Printing Paper	1
Originals	2
Preparation for Printing	3
Loading Paper	3
Setting Up the Paper Delivery Tray	4
Standard Printing	5
Restoring Paper Feed and Paper Delivery Trays	7
Energy Saver Mode — Saving Energy	8
Adjusting the Print Image Position	9
Shifting the Print Image Position Forward or Backward	9
Shifting the Print Image Position to the Right or Left	10
Adjusting the Print Image Density	11
Before Making a Master	11
After Making a Master	11
Tint Mode—Halftone Printing	12
Fine Mode—Making Clear Prints	13
Changing the Printing Speed	14
Stopping the Machine during the Multi-print Run	15
When You Want to Stop the Machine during the Multi-print Run and Print the Next Original	15
When You Want to Change the Number of Prints Entered or Check the Completed Prints	15
Preset Reduce/Enlarge—Reducing and Enlarging Using Preset Ratios ...	16
Centre/Edge Erase—Erasing centre and Edge Margins	18
Edge Erase—Erasing Edge Margins	20
Paste Shadow Erase—Erasing the Shadow of Pasted Originals	22
Printing on Thick or Thin Paper	23
Pressure Lever Position	23
Selecting Original Type	24
Economy Mode—Saving Ink	25
Auto Cycle—Printing from Several Originals at Once	26
Class Mode—Group Printing from the Same Original	28
Memory Mode—Group Printing from Different Originals	30
Combine—Combining 2 Originals onto One Print	33
Skip Feed Printing	37
Program—Storing Your Print Settings in Memory	38

Storing Your Settings	38
Recalling a Program.....	39
Protecting a Program	40
Removing Program Protection	41
Security Mode—Printing Secret Documents	42

2. Optional Functions

Printing Using the Optional 30 Originals Document Feeder	43
Document Feeder Exterior	43
Originals	44
Setting Originals in the Document Feeder	45
Combine Copies with the Document Feeder	46
Memory Mode with the Document Feeder	48
Colour Printing Using the Optional Colour Drum	52
Making Colour Prints.....	52
Changing the colour Drum Unit.....	52
Printing in Two colours.....	54

3. Service Program Mode

Accessing Service Programs	57
Changing the Settings of Service Programs	58
Service Program Menu	59
User Codes.....	66
How to Set User Code Mode (# 120)	66
How to Use User Code Mode	67
How to Check the User Code Counter (# 121)	68
How to Clear the User Code Counter (# 122)	69
How to Check the Total Number of Masters and Prints Made Under All User Codes (# 123)	70
How to Clear the User Code Total Counter (# 124)	71

4. Replenishing Supplies

Loading Paper on the Paper Feed Tray.....	73
Replenishing Paper.....	73
Changing the Paper Size	74
When the Add Ink Indicator (I) Lights.....	75
Master Roll Replacement.....	77
Placing a New Roll of Tape in the Tape Dispenser (Option)	79

5. What to do If Something Goes Wrong

If Your Machine does not Operate as You Want.....	81
☞ Clearing Misfeeds.....	84

“” + “ORIGINAL JAM. REMOVE ORIGINAL” 84
 “” + “PAPER FEED JAM. REMOVE JAMMED PAPER” 87
 “” + “MASTER FEED JAM. REMOVE JAMMED MASTER” 90
 “” + “PAPER WRAP JAM. REMOVE JAMMED PAPER” 92
 “” + “MASTER EJECT JAM. REMOVE JAMMED MASTER” 94
 “” + “DELIVERY JAM. REMOVE JAMMED PAPER” 96

When the Open Cover/Unit Indicator () Lights..... 97
When the Master Eject Indicator () Lights..... 99
When Other Indicators Light 100
When the Prints are Thrown Over the Paper Delivery Tray..... 101
Poor Printing..... 102
 Dirt on the Back Side of Paper 102
 Dirt on the Front Side of Paper (Black Line/Stain) 104
 White Prints or Incomplete Prints..... 105

6. Remarks

Operation Notes..... 107
 General Cautions 107
 Print Paper 109
 Originals 109

Where to Put Your Machine..... 111
 Environmental Conditions 111
 Power Connection..... 112
 Access to Machine 112

Maintaining Your Machine..... 113
 Main Frame 113
 Optional Document Feeder 114

Combination Chart 115

7. Specification

Main Frame..... 117
30 Originals Document Feeder..... 121
Consumables 122
INDEX..... 123

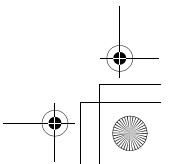
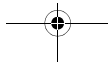
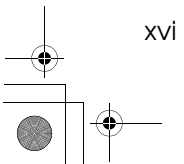
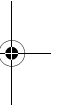
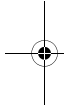
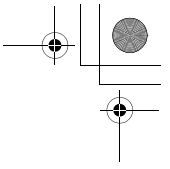
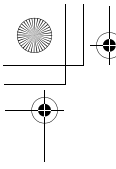

1. Operation

Printing Paper

The following types of print paper are not recommended for this machine.

- Paper smaller than 90mm × 148mm, 3.6" × 5.9"
- Paper larger than 268mm × 388mm, 10.5" × 15.2"
- Paper heavier than 209.3g/m², 55.6 lb
- Paper lighter than 47.1g/m², 12.5 lb
- Roughly-cut paper
- Paper of different thickness in the same stack
- Buckled or curled paper
- Low stiffness paper

Correct curls in the paper before setting it in the machine. When you cannot correct the paper curl, stack the paper with the curl face down. Otherwise the paper might wrap around the drum or stains might appear.

Store paper where it will not curl or absorb moisture. Use paper soon after it is unpacked.

Only use paper where the leading edge has two right angle corners, as shown below.

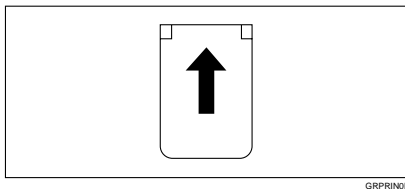

Originals

1

Note

- Originals that can be set on the exposure glass are as follows:
 - Maximum size: 257 × 364mm, 10.2" × 14.4"
 - Maximum total thickness: 30mm, 1.1"
 - Maximum total weight: 5kg, 11.0 lb
- If you use paste-up originals, make sure the pasted parts hold firmly to the base sheet and press the **[Paste Shadow Erase]** key. If the thickness of the paste-up original is more than 0.1mm and the space between the pasted parts is less than 2mm, 0.08", a shadow might appear on the prints.
- If you use originals that have bold letters or solid images at the leading edges, you might get prints with dirty edges. In this case, insert the widest margin first, or raise the printing speed.
- The first 5mm, 0.2" of the leading edge cannot be printed. Make sure the leading edge margin is at least 5mm, 0.2".

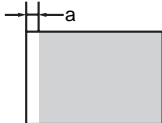
Original	Print
	

- a: 5mm, 0.2"

2

Preparation for Printing

Loading Paper

- 1** Carefully open the paper feed tray.

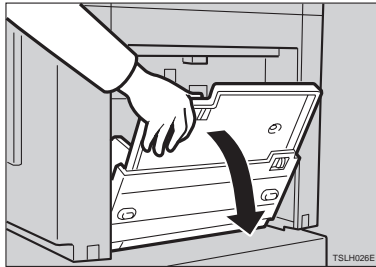

- 2** Put the paper feed side plates lock lever. Adjust the side plates to match the paper size.

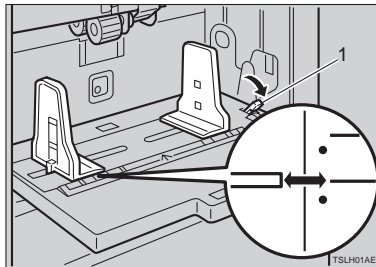

1: Paper Feed Side Plates Lock Lever

- 3** Place the paper on the paper feed tray.

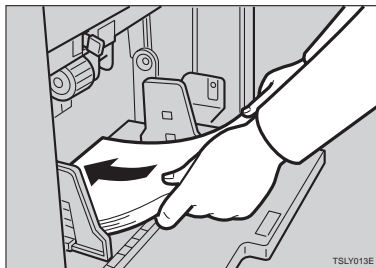

Note

- ❑ Correct the paper curl before setting the paper. If you cannot do so, stack the paper with the curl face down as shown.

1

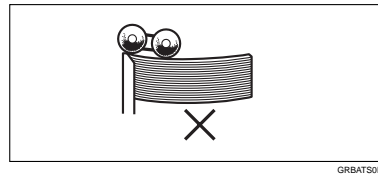
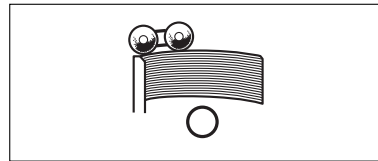

- 4** Make sure that the paper feed side plates touch the paper lightly. Put back the lock lever.

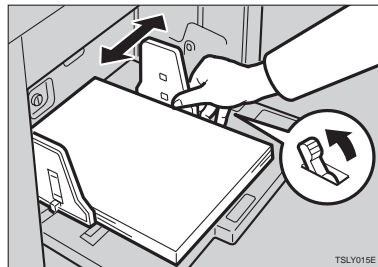

3

Operation

Setting Up the Paper Delivery Tray

1

1 Open the paper delivery tray.

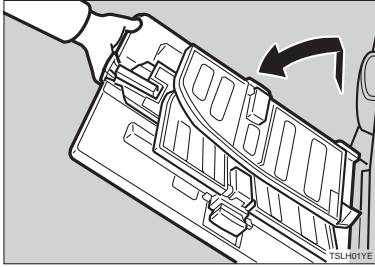

3 Lift the paper delivery end plate and move it to match the print paper size.

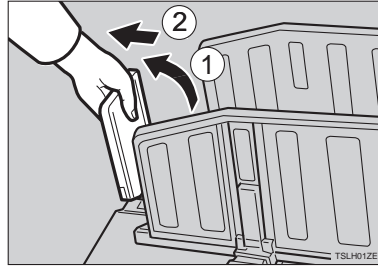

Reference

When the prints are not delivered in a neat stack, see ⇒ P.101 "When the Prints are Thrown Over the Paper Delivery Tray".

4 Turn on the main switch.

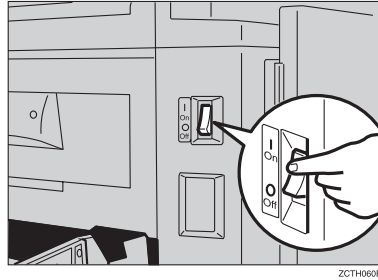

2 Lift the paper delivery side plates and adjust them to the paper size.

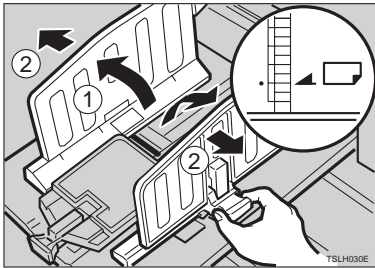

Standard Printing

Printing

In this manual, the word, "Printing" is used as opposed to "Copying" in order to distinguish between the process that your machine uses to make prints, and the process used by a standard copier machine.

A standard copier scans in the original for each copy set made. This machine, however, scans in your original once and makes multiple prints from this master.

This chapter describes the basic pointing operations that your machine is capable of.

1 Lift the platen cover.

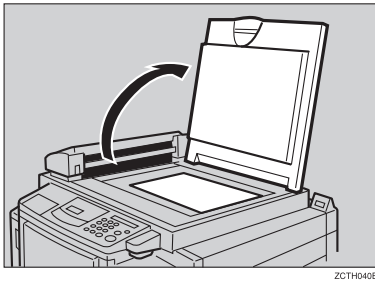

ZCTH040E

2 Set the original face down on the exposure glass. The original should be centred according to the size marks on the right scale.

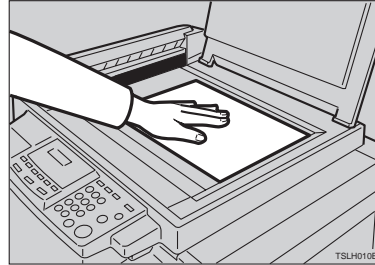

TSLH010E

3 Lower the platen cover.

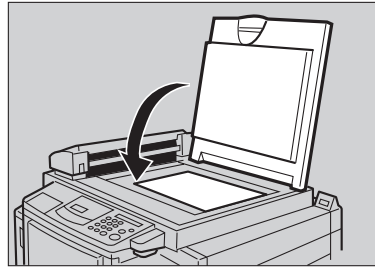

ZCTH050E

4 Press the [Start] key.

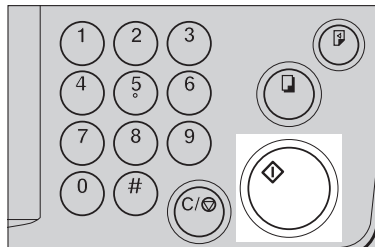

TSLS012E

A trial print is delivered to the paper delivery tray.

1

5

Operation

- 5** Press the **[Proof]** key and check the image density and the image position of the proof print.

1

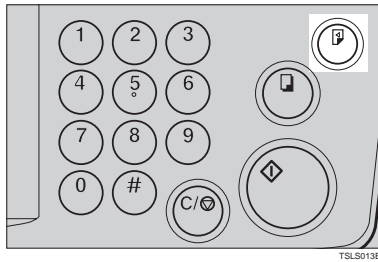

Note

- If the image position is not correct, adjust it using the **[Image Position]** keys or the fine adjustment dial. See ⇒ P.9 “Adjusting the Print Image Position”.
- If the image density is slightly dark or light, adjust the image density using the **[◀]** or **[▶]** key. See ⇒ P.11 “Adjusting the Print Image Density”.

- 6** Enter the number of prints required with the number keys.

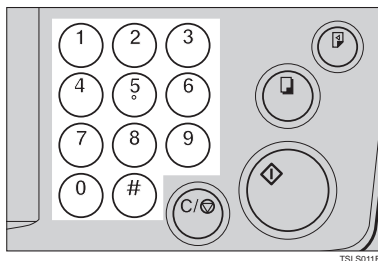

Note

- Up to 9999 prints can be entered at one time.
- To change the number entered, press the **[Clear/Stop]** key and enter the new number.

- 7** Press the **[Print]** key.

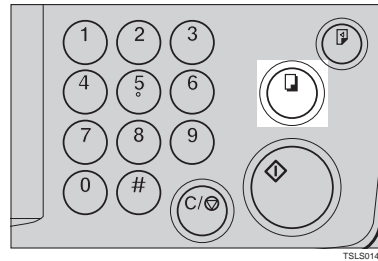

Note

- After printing is completed, the same number of prints is automatically set for the next job.
- To stop the machine during the multi-print run, press the **[Clear/Stop]** key.
- To return the machine to the initial condition after printing, press the **[Clear Modes/Energy Saver]** key.

Restoring Paper Feed and Paper Delivery Trays

- 1** Remove the paper from the paper feed tray.

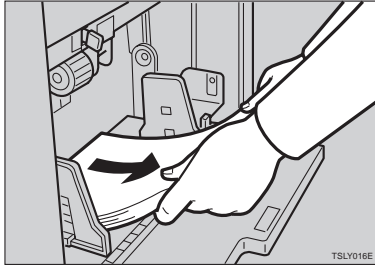

The paper feed tray will lower.

- 2** Turn off the main switch.

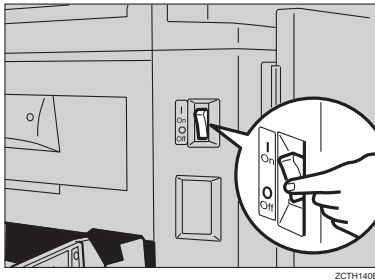

- 3** Close the paper feed tray.

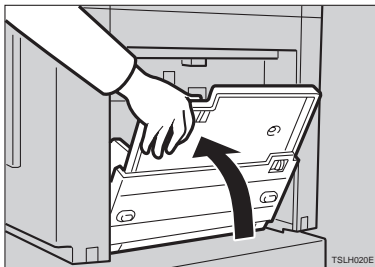

- 4** Move the end plate until the plate handle is flush with the end of the tray.

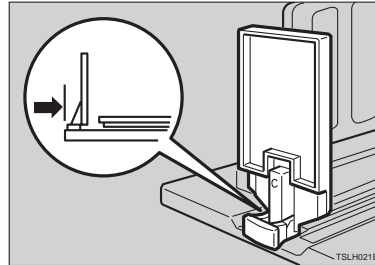

- 5** Lower the end plate.

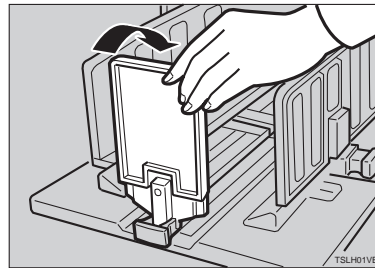

- 6** Move the side plates to the sides, then lower them.

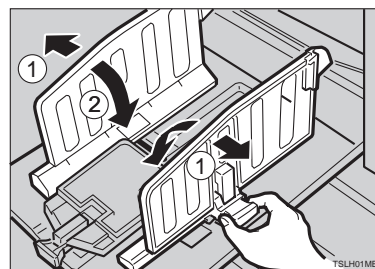

- 7** Close the tray.

1

7

Operation

Energy Saver Mode — Saving Energy

1

If you do not operate the machine for a certain period after printing, or when you press and hold the **[Clear Modes/Energy Saver]** key for three seconds, the panel display turns off and the machine enters Energy Saver mode. When you press the **[Clear Modes/Energy Saver]** key again, the machine returns to the ready condition. In Energy Saver mode, the machine uses less electricity.

See "Auto Energy Saving" ⇒ P.59 "Service Program Menu".

Adjusting the Print Image Position

After master making, you can adjust the print image position to suit your needs. There are two ways:

❖ Shifting the Image Position Forward or Backward

Shift the image position using the **[Image Position]** keys.

❖ Shifting the Image Position to the Right or Left

Shift the image position using the side tray fine adjusting dial.

Shifting the Print Image Position Forward or Backward

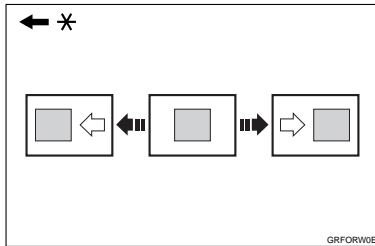

* Paper feed direction

1 Press the left **[Image Position]** key to move the image forwards, the right key to move it backwards.

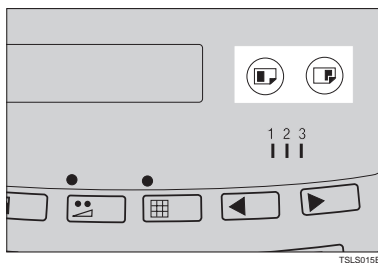

Note

- ❑ When you shift the image forwards, leave a margin (more than 5mm, 0.2") at the leading edge. If there is no margin, paper might wrap around the drum and cause a misfeed.
- ❑ The right or left **[Image Position]** keys shift the image about 0.5mm, 0.02" each time they are pressed. When the indicator changes, the image position shifts about 5mm, 0.2".

2 Press the **[Proof]** key to check the image position.



1

Operation

Shifting the Print Image Position to the Right or Left

1

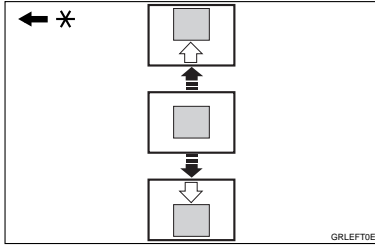

* Paper feed direction

1 Turn the side tray fine adjusting dial as shown in the illustrations.

◆ Shifting the image to the right



◆ Shifting the image to the left



Note

□ The image position can be shifted up to about 10mm, 0.4" each way. Each division on the scale is 2mm, 0.08".

2 Adjust the paper delivery side plates to the print paper position.

3 Press the **[Proof]** key to check the image position.

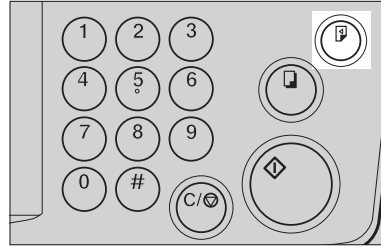

Adjusting the Print Image Density

You can adjust the print image density to suit your needs. There are two ways:

- ❖ **Before Making a Master**
Adjust the image density using the **[Image Density]** key.
- ❖ **After Making a Master**
Adjust the image density using the **[◀]** or **[▶]** key.

Before Making a Master

- 1 Use the **[Image Density]** key before pressing the **[Start]** key.

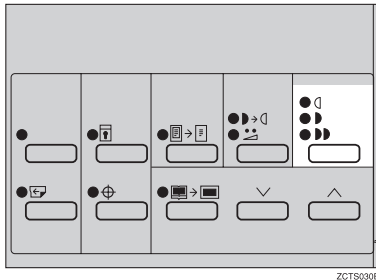

After Making a Master

- 1 Press the **[◀]** or **[▶]** key. To increase the speed, press the **[▶]** key. To reduce the speed, press the **[◀]** key.

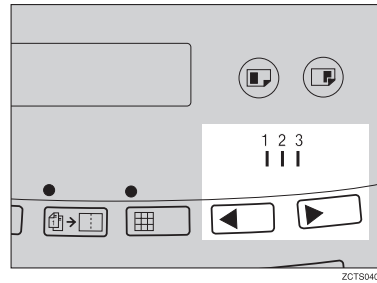

Note

- The faster the printing speed becomes, the lighter the printing density is. If you want darker prints, decrease the printing speed.

Tint Mode—Halftone Printing

1

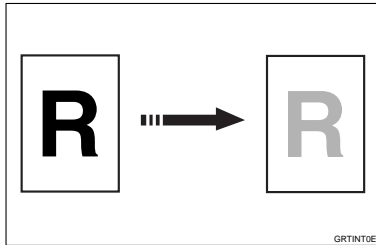

Use the **[Tint/Economy]** key to make halftone prints.

- 1 Press the **[Tint/Economy]** key to select Tint mode (Upper indicator).

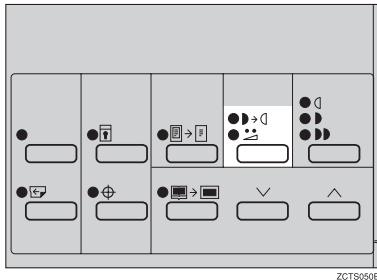

- 2 Set your originals on the exposure glass or in the optional document feeder.

- 3 Press the **[Start]** key.

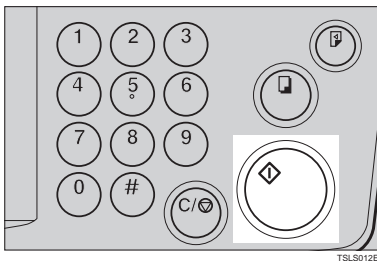

- 4 Check the image position of the trial or proof print.

Note

- If the image position is not correct, adjust it using the **[Image Position]** keys (see ⇒ P.9 “Adjusting the Print Image Position”) or the side tray fine adjusting dial (see ⇒ P.10 “Shifting the Print Image Position to the Right or Left”).

- 5 Enter the number of prints with the number keys.

- 6 Press the **[Print]** key.

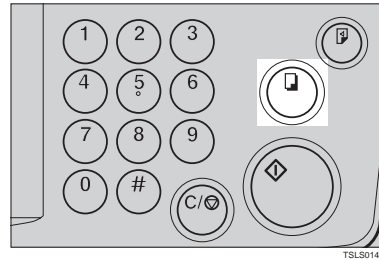

Fine Mode—Making Clear Prints

Use the **[Fine]** key to make clear prints.

- 1 Press the **[Fine]** key to select Fine mode.

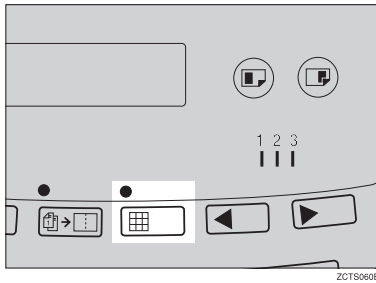

- 4 Enter the number of prints with the number keys.

- 5 Press the **[Print]** key.

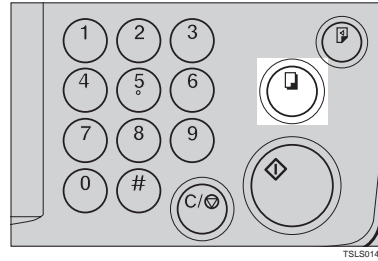

- 2 Set your originals on the exposure glass or in the optional document feeder.

- 3 Press the **[Start]** key. Check the image position of the trial or proof print.

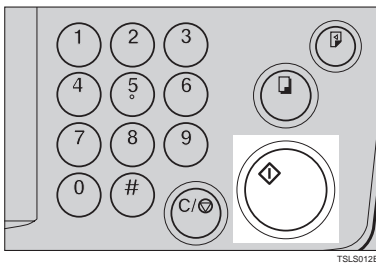

Note

- If the image position is not correct, adjust it using the **[Image Position]** keys (see ⇒ P.9 “Adjusting the Print Image Position”) or the side tray fine adjusting dial (see ⇒ P.10 “Shifting the Print Image Position to the Right or Left”).

Changing the Printing Speed

1

Use the [◀] or [▶] key to adjust the speed of the machine with the image density and printing paper.

1 Press the [▶] key to increase the speed and press the [◀] key to reduce the speed.

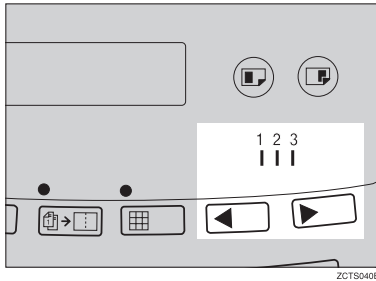

Note

- The following speeds are available:
 - Setting 1:
80 sheets/minute
 - Setting 2:
100 sheets/minute
 - Setting 3:
130 sheets/minute
- As a default setting, setting 2 is selected.
- The faster the printing speed becomes, the lighter the printing density is, and vice versa.

Stopping the Machine during the Multi-print Run

When You Want to Stop the Machine during the Multi-print Run and Print the Next Original

- 1 Press the **[Clear/Stop]** key.

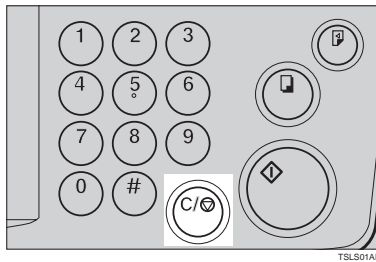

- 2 Set the new original.

- 3 Enter the number of prints and press the **[Start]** key.

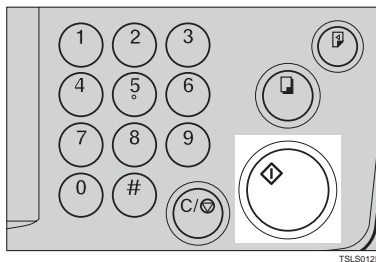

When You Want to Change the Number of Prints Entered or Check the Completed Prints

- 1 Press the **[Clear/Stop]** key.

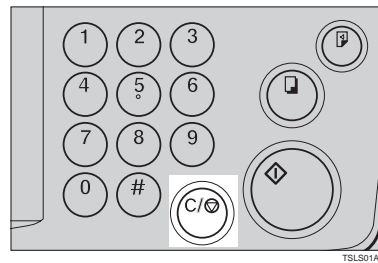

- 2 Change the number of prints or check the completed prints.

Note

- When you change the number of prints, you can re-enter the number with the number keys after pressing the **[Clear/Stop]** key.

- 3 Press the **[Print]** key.

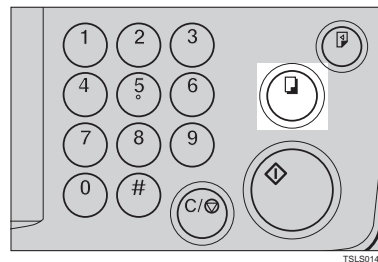

1

Operation

Preset Reduce/Enlarge—Reducing and Enlarging Using Preset Ratios

1

You can select a preset ratio for printing.

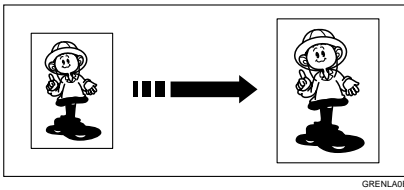
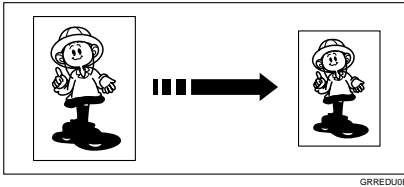

Note

- The centre and the leading edge of the print image do not shift when a print image is made with this function.

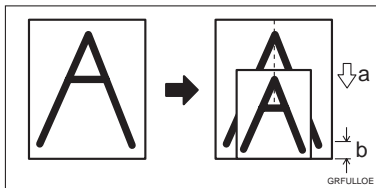

a: Paper Feed Direction

b: Constant

- You can select one of 7 preset ratios (3 enlargement ratios, 4 reduction ratios).
- You can select a ratio regardless of the size of an original or printing paper. With some ratios, parts of the image might not be printed or margins will appear on prints.

- Prints can be reduced or enlarged as follows:

◆ Reduction (Metric version)

Reduction Ratio	Original Size	Print Size
93 %	*1	
87 %	A5	B6
	A4	B5
82 %	B4	A4
	B5	A5
71 %	A4	A5
	B4	B5

*1 Select this ratio when you make prints with a lot of edge margins.

◆ Reduction (Inch version)

Reduction Ratio	Original Size	Print Size
93 %	*1	
77 %	8 ¹ / ₂ " × 14"	8 ¹ / ₂ " × 11"
74 %	10" × 14"	8 ¹ / ₂ " × 11"
65 %	8 ¹ / ₂ " × 11"	5 ¹ / ₂ " × 8 ¹ / ₂ "
		8 ¹ / ₂ "

*1 Select this ratio when you make prints with a lot of edge margins.

◆ Enlargement (Metric version)

Enlarge-ment Ratio	Original Size	Print Size
141 %	B5	B4
	A5	A4
122 %	A4	B4
	A5	B5
115 %	B5	A4
	B6	A5

◆ Enlargement (Inch version)

Enlarge-ment Ratio	Original Size	Print Size
155 %	5 ¹ / ₂ " × 8 ¹ / ₂ "	8 ¹ / ₂ " × 14"
129 %	5 ¹ / ₂ " × 8 ¹ / ₂ "	8 ¹ / ₂ " × 11"
121 %	—	—

- 1 Select the desired reduction or enlargement ratio using the **[Reduce]** key or the **[Enlarge]** key.

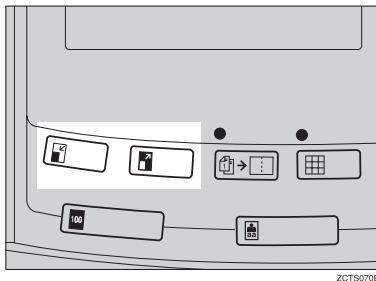

- 2 Make sure that the original and the print paper are the correct size.
- 3 Set your originals on the exposure glass or in the optional document feeder.

- 4 Press the **[Start]** key.

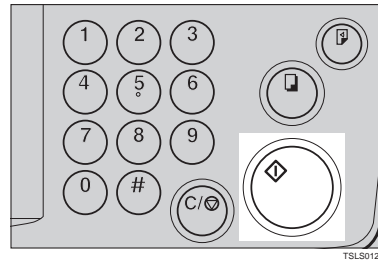

- 5 Check the image position of the trial or proof print.

Note

- If the image position is not correct, adjust it using the **[Image Position]** keys (see ⇒ P.9 "Shifting the Print Image Position Forward or Backward") or the side tray fine adjusting dial (see ⇒ P.10 "Shifting the Print Image Position to the Right or Left").

- 6 Make your prints.

1

Operation

Centre/Edge Erase—Erasing centre and Edge Margins

1

When printing from thick books, or similar originals, the binding margin at the centre and the edges might appear on prints. To prevent this, follow the steps below.

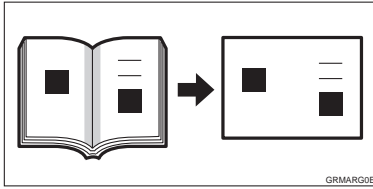

Note

- As a default setting, the paper sizes and directions that can be used are as follows:

Metric version	B4, A4, A5, A5, B5, B5
Inch version	8 1/2" x 14", 8 1/2" x 11", 5 1/2" x 8 1/2", 5 1/2" x 8 1/2"

- If you want to use other size originals, you can register the size using Service Program mode (See ⇒ P.59 "Service Program Menu").
- The margin width to be erased can be adjusted with Service Program mode (See ⇒ P.59 "Service Program Menu").

- Press the **[Center/Edge Erase]** key twice to select the Centre/Edge Erase mode.

Check Indicator is blinking and is shown in the guidance display.

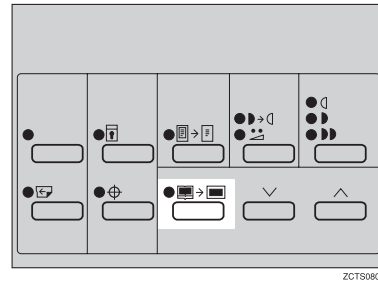

Note

- To cancel this mode, press the **[Center/Edge Erase]** key again.

- Press the **[∨]** or **[∧]** key to select the paper size and direction.

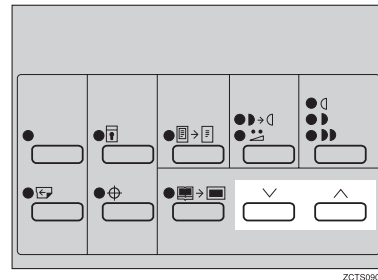

- 3** When you reach the desired paper size and direction, press the **[#]** key.

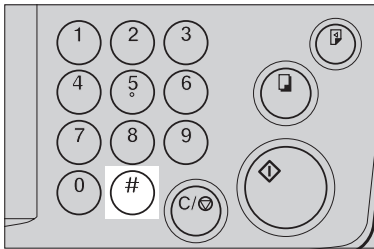

- 4** Set the book on the exposure glass.

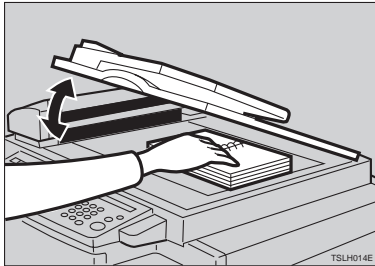

- 5** Press the **[Start]** key.

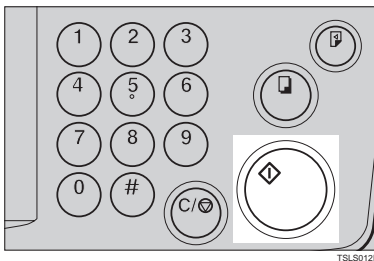

- 6** Check the image position of the trial or proof print.

Note

- If the image position is not correct, adjust it using the **[Image Position]** keys (see ⇒ P.9 “Adjusting the Print Image Position”) or the side tray fine adjusting dial (see ⇒ P.10 “Shifting the Print Image Position to the Right or Left”).

- 7** Enter the number of prints with the number keys.

- 8** Press the **[Print]** key.

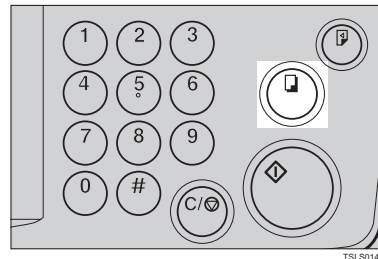

1

Operation

Edge Erase—Erasing Edge Margins

1

If you want to erase edge margins of a book original, follow the steps below.

 **Note**

- As a default setting, the paper sizes and directions that can be used are as follows:

Metric version	B4□, A4□, A5□, A5□, B5□, B5□
Inch version	8 ¹ / ₂ " × 14"□, 8 ¹ / ₂ " × 11"□, 5 ¹ / ₂ " × 8 ¹ / ₂ "□, 5 ¹ / ₂ " × 8 ¹ / ₂ "□

- If you want to use other size originals, you can register the size using Service Program mode (See ⇒ P.59 "Service Program Menu").
- The margin width to be erased can be adjusted with Service Program mode (See ⇒ P.59 "Service Program Menu").

- 1** Press the **[Center/Edge Erase]** key to select Edge Erase mode.

Check Indicator is blinking and  is shown in the guidance display.

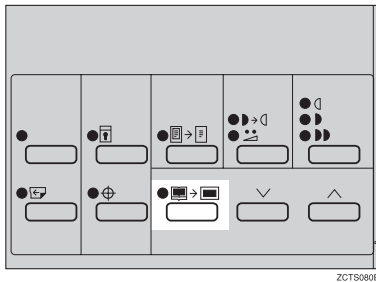

 **Note**

- To cancel this mode, press the **[Center/Edge Erase]** key twice.

- 2** Press the **[√]** or **[∧]** key to select the paper size and direction.

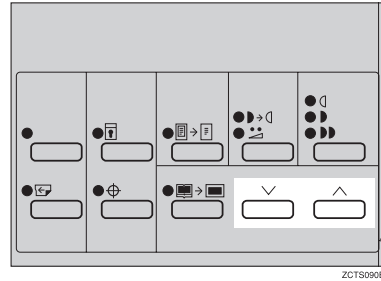

- 3** When you reach the desired paper size and direction, press the **[#]** key.

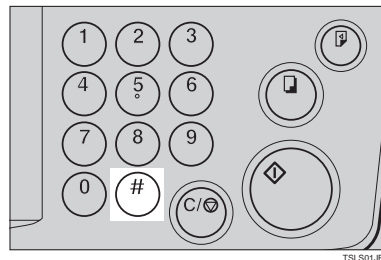

- 4** Set the book on the exposure glass.

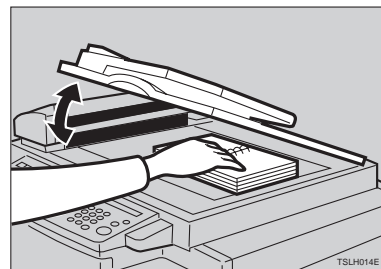

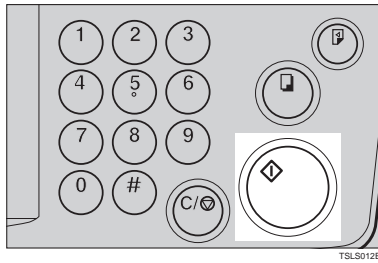
5 Press the **[Start]** key.

1

6 Check the image position of the trial or proof print.**Note**

- If the image position is not correct, adjust it using the **[Image Position]** keys (see ⇒ P.9 “Adjusting the Print Image Position”) or the side tray fine adjusting dial (see ⇒ P.10 “Shifting the Print Image Position to the Right or Left”).

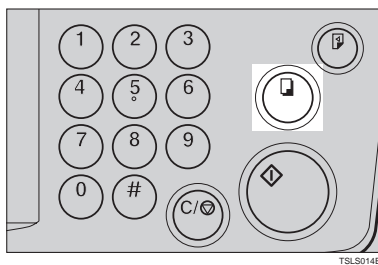
7 Enter the number of prints with the number keys.**8** Press the **[Print]** key.

Operation

Paste Shadow Erase—Erasing the Shadow of Pasted Originals

1

If you want to erase the shadow of pasted originals, follow the steps below.

1 Set the original on the exposure glass.

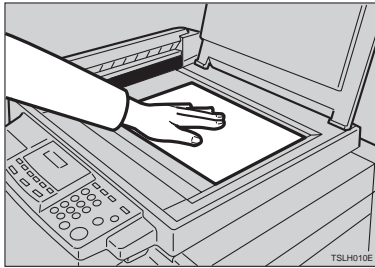

4 Enter the number of prints with the number keys.

5 Press the **[Print]** key.

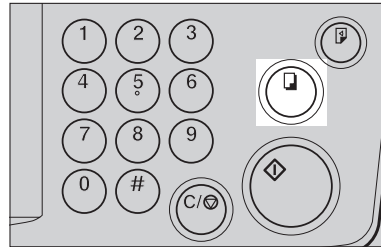

2 Press the **[Paste Shadow Erase]** key.

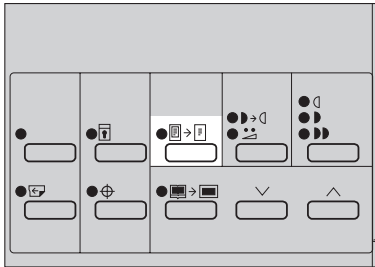

3 Press the **[Start]** key.

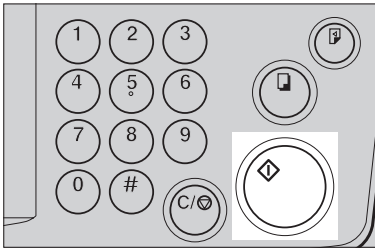

Printing on Thick or Thin Paper

When you make prints on thick (127.9 to 209.3g/m², 34.0 to 55.6 lb), standard (52.3 to 127.9g/m², 13.9 to 34.0 lb) or thin (47.1 to 52.3g/m², 12.5 to 13.9 lb) paper, perform the following steps.

Pressure Lever Position

- 1** Position pressure lever to thick, standard, or thin paper position.

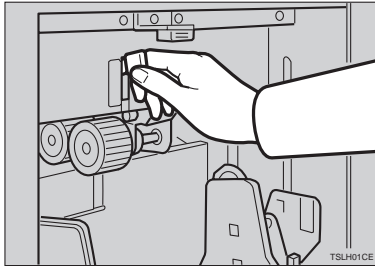

Note

- When you use paper heavier than 127.9g/m², 34.0 lb and lighter than 209.3g/m², 55.6 lb, position pressure lever to the Thick paper position.
- When you use paper heavier than 52.3g/m², 13.9 lb and lighter than 127.9g/m², 34.0 lb, position pressure lever to the Standard paper position.
- When you use paper heavier than 47.1g/m², 12.5 lb and lighter than 52.3g/m², 13.9 lb, position pressure lever to the Thin paper position.

- In the case of paper smaller than B5, 5¹/₂" × 8¹/₂" and heavier than 81.4g/m² (21.6 lb), move the feed roller pressure lever to the Thin paper position.

- 2** Make sure that paper feed side plates touch the paper lightly.

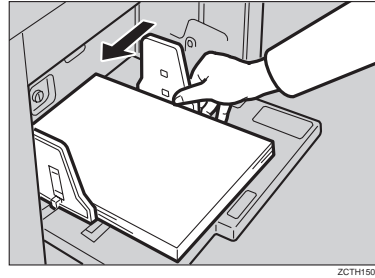

- 3** When you finish prints, position pressure lever to the Standard paper position.

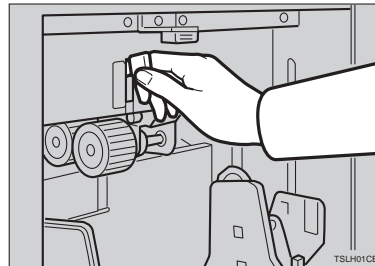

1

Selecting Original Type

1

Select one of the following three types to match your originals:

❖ Photo mode

Delicate tones of photographs and pictures can be reproduced with this mode.

❖ Letter mode

Select this mode when your originals contain only letters (no pictures).

❖ Letter/Photo mode

Select this mode when your originals contain photographs or pictures with letters.

📎 Note

- Moire patterns might occur when screened originals are printed.
- When using Photo mode to print originals with both letter and photographs, the letter will appear lighter. To avoid this, select Letter/Photo mode with the **[Type of Original]** key.

1 Press the **[Type of Original]** key to select Photo mode.

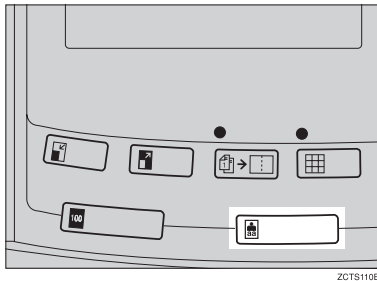

2 Press the **[Image Density]** key to adjust the image density.

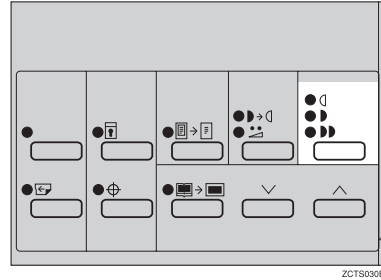

3 Set your originals on the exposure glass or in the optional document feeder.

4 Press the **[Start]** key.

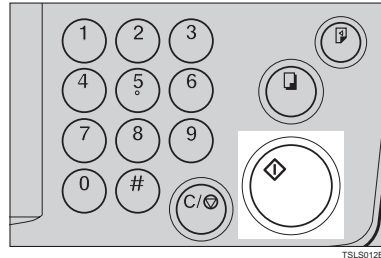

5 Check the image position of the trial or proof print.

📎 Note

- If the image position is not correct, adjust it using the **[Image Position]** keys (see ⇒ P.9 "Shifting the Print Image Position Forward or Backward") or the side tray fine adjusting dial (see ⇒ P.10 "Shifting the Print Image Position to the Right or Left").

6 Make your prints.

Economy Mode—Saving Ink

When you want to save ink, select Economy mode.

Note

- Prints will come out lighter.

1 Press the **[Tint/Economy]** key to select Economy mode (Lower indicator).

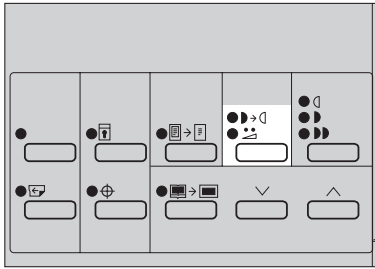

ZCTS050E

2 Set your originals on the exposure glass or in the optional document feeder.

3 Press the **[Start]** key.

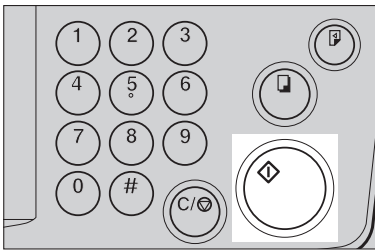

TSL5012E

4 Check the image position of the trial or proof print.

Note

- If the image position is not correct, adjust it using the **[Image Position]** keys (see ⇒ P.9 “Shifting the Print Image Position Forward or Backward”) or the side tray fine adjusting dial (see ⇒ P.10 “Shifting the Print Image Position to the Right or Left”).

5 Make your prints.

1

Auto Cycle—Printing from Several Originals at Once

1

Use the **[Auto Cycle]** key to process masters and make prints at one stroke.

Note

- When you use the optional document feeder, it is not necessary to place originals one by one. All originals are fed and prints are completed after you press the **[Print]** key.
- If you use the optional tape dispenser, the tape dispenser drops a strip of paper onto the top of the paper stack after the last page of each printing set is fed out to the paper delivery tray. This marks the end of each printing group.

1 Set the original on the exposure glass or in the optional document feeder.

Note

- You can set up to 30 originals into the optional document feeder.

2 Enter the number of prints required with the number keys.

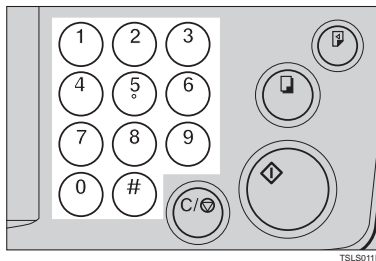

3 Press the **[Start]** key.

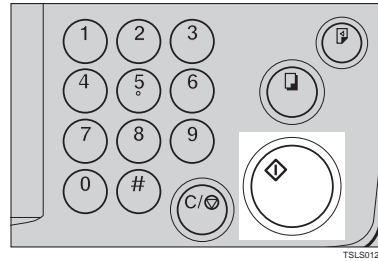

4 Check the image position of the trial or proof print.

Note

- If the image position is not correct, adjust it using the **[Image Position]** keys (see ⇒ P.9 “Shifting the Print Image Position Forward or Backward”) or the side tray fine adjusting dial (see ⇒ P.10 “Shifting the Print Image Position to the Right or Left”).

5 Press the **[Auto Cycle]** key.

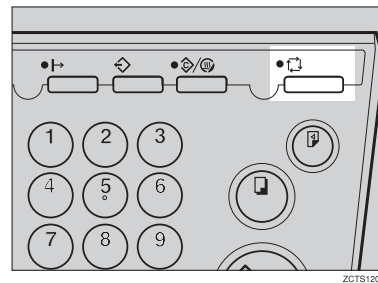

Note

- If you press the **[Auto Cycle]** key, you cannot make proof prints by pressing the **[Proof]** key.

- 6** If you use the optional tape dispenser, turn on the tape dispenser power switch.

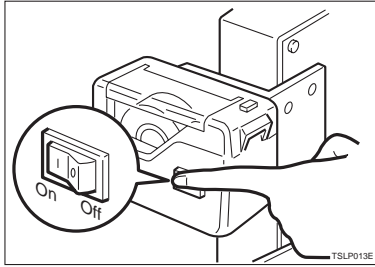

1

- 7** Press the **[Print]** key.

Note

- Repeat steps **1** through **5** until all originals are printed when you set originals on the exposure glass.
- If you set originals into the optional document feeder, originals are fed and prints are completed automatically.
- After the last page of each set is fed out to the paper delivery tray, the optional tape dispenser drops a strip of paper on the top of the paper stack. The next cycle begins.

Operation

Class Mode—Group Printing from the Same Original

1

Use the **[Memory/Class]** key to make sets of prints from the same original. The same number of prints is made for each set.

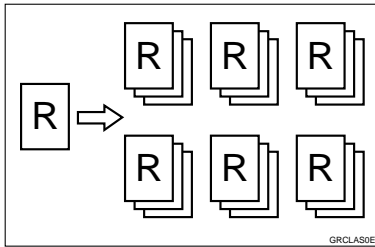

Note

- The optional tape dispenser automatically feeds out strips of paper which separate the printing groups on the paper delivery tray.
- Up to 20 sets of prints can be selected for one original.

1 Press the **[Memory/Class]** key to light the Class indicator.

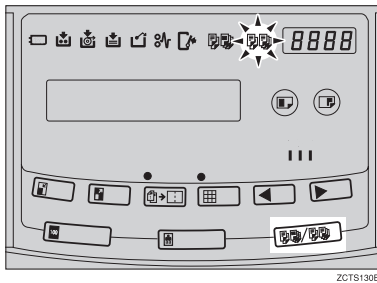

2 With the number keys, enter the number of prints for each set to be made from the original.

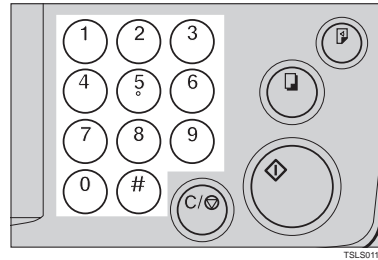

3 Press the **[#]** key.

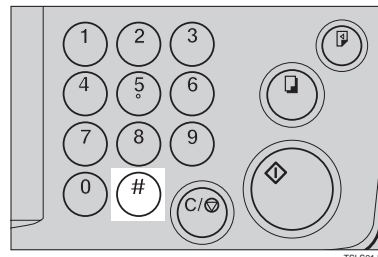

4 With the number keys, enter the desired number of sets.

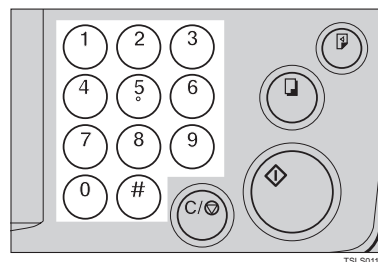

Note

- The maximum number of sets that can be made is 20.

- 5** Turn on the optional tape dispenser power switch.

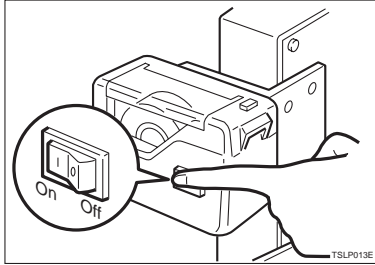

- 6** Set one original face down on the exposure glass or in the optional document feeder.

- 7** Press the **[Start]** key.

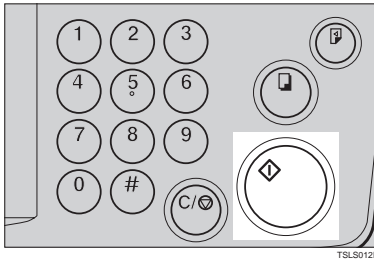

- 8** Check the image position of the trial or proof print.

Note

- If the image position is not correct, adjust it using the **[Image Position]** keys (see ⇒ P.9 “Shifting the Print Image Position Forward or Backward”) or the side tray fine adjusting dial (see ⇒ P.10 “Shifting the Print Image Position to the Right or Left”).

- 9** Make your prints.

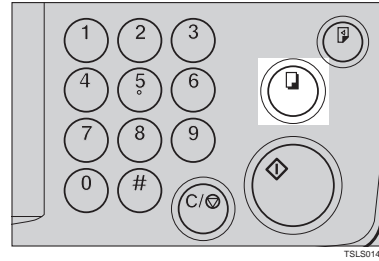

1

Note

- After the last page of each printing set is fed out to the paper delivery tray, the tape dispenser drops a strip of paper on the top of the paper stack.
- If the power switch of the optional tape dispenser is turned off or the tape dispenser is not installed in your machine, the group printing cycle stops after each set is delivered. Remove the set of prints from the paper delivery tray and press the **[Print]** key to start the next group printing cycle.

Memory Mode—Group Printing from Different Originals

1

Use the **[Memory/Class]** key to make sets of prints from different originals.

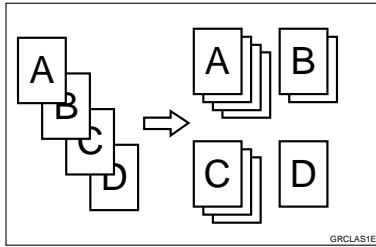

Note

- With the optional document feeder, you can set several originals and make prints of all of them at once. See ⇒ P.48 "Memory Mode with the Document Feeder".
- The optional tape dispenser automatically feeds out strips of paper which separate the printing groups on the paper delivery tray.

1 Press the **[Memory/Class]** key to light the Memory indicator.

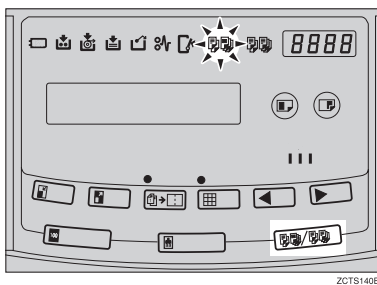

2 With the number keys, enter the desired number of prints for the first original.

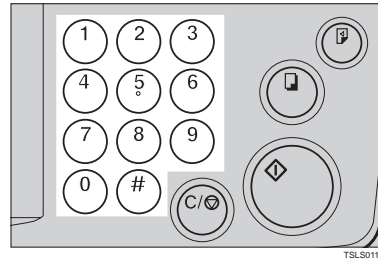

3 Press the **[#]** key.

This stores the number of prints to be made for the first original in memory 1.

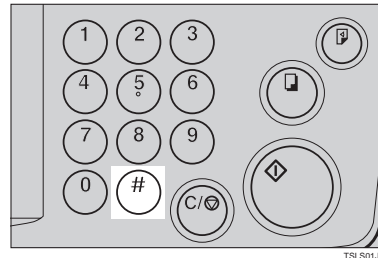

Note

- When the number of prints in each set is the same, it is not necessary to input the number of prints for each group in memory. Simply select Auto Cycle mode and enter the desired number of prints once.

- 4** With the number keys, enter the number of prints for the second original.

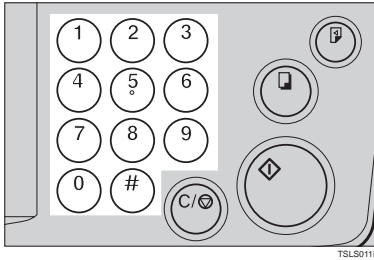

- 5** Press the [#] key.

This stores the number of prints to be made for the second original in memory 2.

Note

- Repeat steps **4** and **5** for each original.
- The number of prints for up to 20 originals can be stored.

- 6** Press the [#] key again.

The memory returns to memory 1.

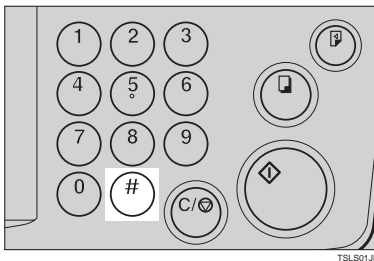

Note

- If you store the number of prints for 20 originals, the memory number returns to 1. It is not necessary to press the [#] key.

- 7** Set the first original face down on the exposure glass.

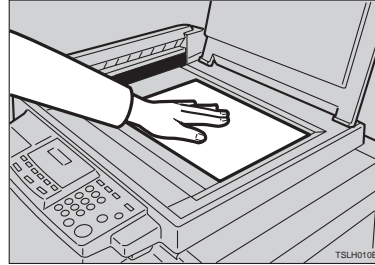

1

Note

- Set originals one sheet at a time in the same order that you stored them in memory.

- 8** Press the [Start] key.

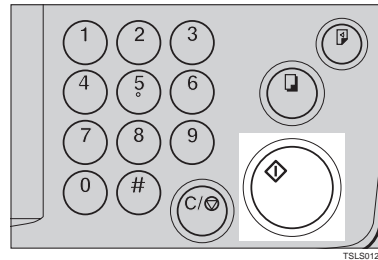

- 9** Check the image position of the trial or proof print.

Note

- If the image position is not correct, adjust it using the [Image Position] keys (see ⇒ P.9 "Shifting the Print Image Position Forward or Backward") or the side tray fine adjusting dial (see ⇒ P.10 "Shifting the Print Image Position to the Right or Left").

Operation

- 10** Turn on the optional tape dispenser power switch.

1

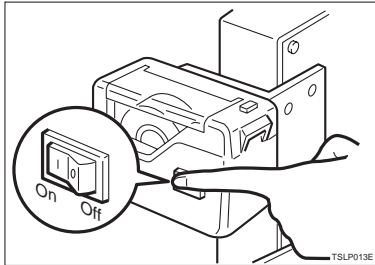

- 11** Press the **[Auto Cycle]** key.

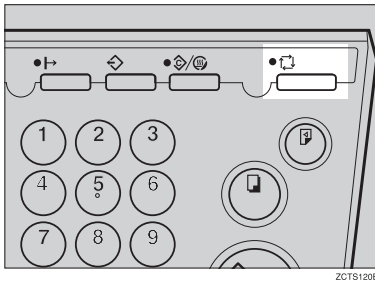

Note

- If you press the **[Auto Cycle]** key, you cannot make proof prints by pressing the **[Proof]** key.

- 12** Press the **[Print]** key.

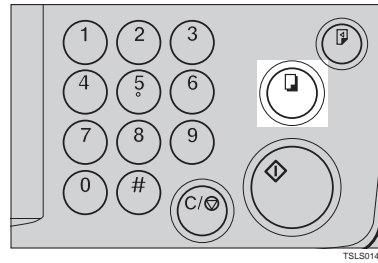

Note

- After the first set is fed to the paper delivery tray, the optional tape dispenser drops a strip of paper on the top of the paper stack.

- 13** After the first set is completed, set the second original on the exposure glass and press the **[Start]** key.

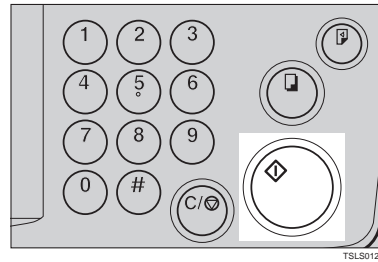

Note

- Repeat this step until you have finished printing.

Combine—Combining 2 Originals onto One Print

You can print 2 separate originals on a single sheet of paper. The following diagrams show the available paper lists and orientations.

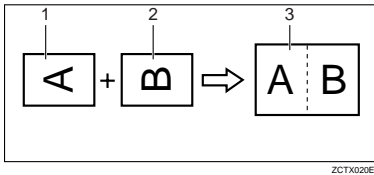

- 1: B4^{*1} or A4[□].
- 2: B4^{*1} or A4[□].
- 3: B4^{*1} or A4[□].
- ^{*1} B4 drum only.

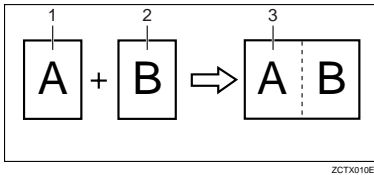

- 1: B5[□], A5[□], B6[□] or A6[□].
- 2: B5[□], A5[□], B6[□] or A6[□].
- 3: B4[□]^{*1}, A4[□], B5[□] or A5[□].
- ^{*1} B4 drum only.

Note

- The following tables list the reproduction ratios used.

◆ **Metric version**

		Original Size					
		B4 [□]	A4 [□]	B5 [□]	A5 [□]	B6 [□]	A6 [□]
Paper Size	B4 [□]	71 %	87 %	100 %	122 %	141 %	--
	A4 [□]	--	71 %	82 %	100 %	115 %	141 %
	B5 [□]	--	--	71 %	87 %	100 %	122 %
	A5 [□]	--	--	--	71 %	82 %	100 %

◆ **Inch version**

		Original Size	
		8 ¹ / ₂ " × 11" [□]	5 ¹ / ₂ " × 8 ¹ / ₂ " [□]
Paper Size	8 ¹ / ₂ " × 14" [□]	77 %	100 %
	8 ¹ / ₂ " × 11" [□]	65 %	100 %
	5 ¹ / ₂ " × 8 ¹ / ₂ " [□]	--	65 %

- If the master length of the first original is longer than the maximum allowable length, or shorter than the minimum allowable length, Combine Copies mode is disabled. The following table gives the maximum and minimum allowable master length.

Operation

1

	Minimum	Maximum
A4 drum model	91 mm, 3.6"	198 mm, 7.7"
B4 drum model	91 mm, 3.6"	243 mm, 9.5"









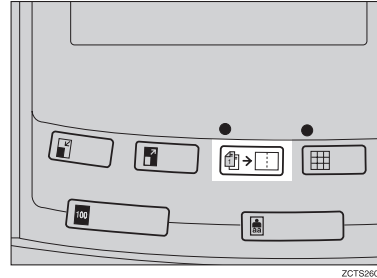



- Master length = actual original length × Enlargement/Reduction ratio
- Any image closer than 5mm, 0.2" to the leading edge of the first original will not be printed. Also, any image closer than 4mm, 0.16" to the leading edge of the second original will not be printed. When the image is too close to the leading edge, use copies of the originals with the image shifted at least 5mm, 0.2" for the first original (4mm, 0.16" for the second original) from the leading edge.
- You can select different image settings for the first and second original.
- Make sure that the paper feed side plates touch the paper lightly when using the Combine Copies function. If they do not, the two original images will not appear at the proper position on the prints.

Reference

For how to use the optional document feeder with this function, see ⇒ P.30 "Memory Mode—Group Printing from Different Originals".

- 1** Press the **[Combine]** key once or more to select the type of combine (see below).



		B4 drum	A4 drum
Number of Key presses	1	A4   → A4 	A4   → A4 
	2	A4   → B4 	71-141% (Manual Settings)
	3	B4   → B4 	No Combine
	4	71-141% (Manual Settings)	—
	5	No Combine	—

- 2** Set the first original face down.

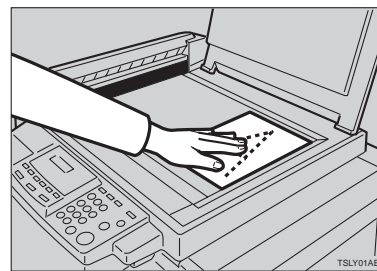

Note

- The first original will be printed on the leading part of the print.

To Choose a Custom Reproduction Ratio

1 Press the **[Center/Edge Erase]** key twice.

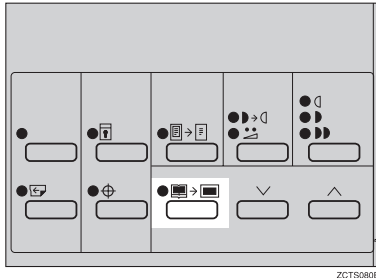

ZCTS080E

2 Press the **[∨]** and **[∧]** key to select the original size and direction.

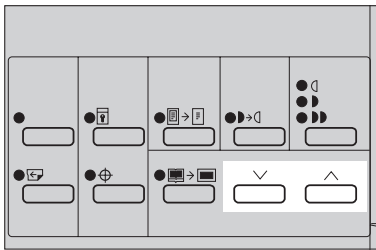

TSL501DE

3 When you reach the desired size and direction, press the **[#]** key.

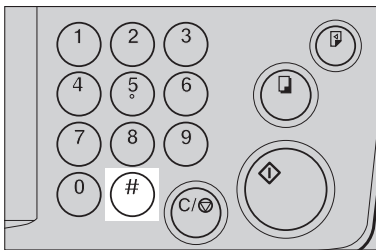

TSL501JE

3 Press the **[Start]** key.

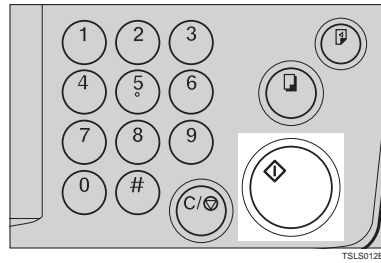

TSL501ZE

4 The beeper sounds after the first original is on the master. Set the second original face down.

5 Press the **[Start]** key.

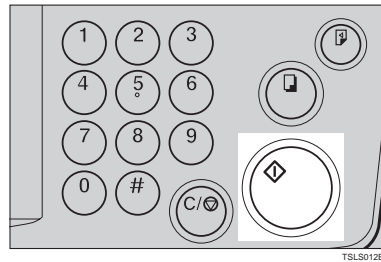

TSL501ZE

6 Check the image position of the trial or proof print.

Note

- If the image position is not correct, adjust it using the **[Image Position]** keys (see ⇒ P.9 "Shifting the Print Image Position Forward or Backward") or the side tray fine adjusting dial (see ⇒ P.10 "Shifting the Print Image Position to the Right or Left").

Operation

7 Enter the number of prints with the number keys.

1

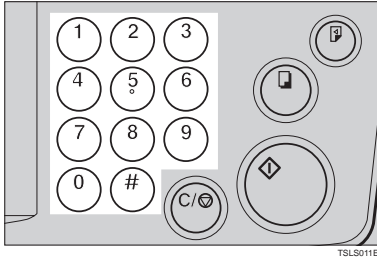

8 Make your prints.

Skip Feed Printing

If the backs of prints are dirty, you can increase the time between two prints using the **[Skip Feed]** key. In the default setting, when one sheet of paper is fed the drum rotates twice. However, you can select the number of rotations of the drum. This gives you the chance to remove prints one by one from the paper delivery tray or insert one sheet of paper between two prints.

- 1** Set your originals on the exposure glass or in the optional document feeder.
- 2** While holding down the **[Skip Feed]** key, select the number of rotations of the drum while one sheet of paper is fed with the number keys.

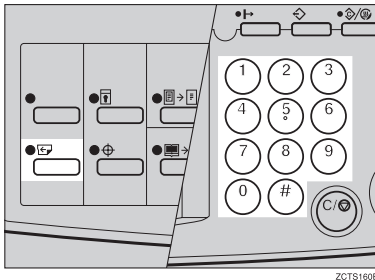

Note

- You can select from 1 to 9 rotations.
- The beeper sounds after you set the number of rotations.

- 3** Press the **[Start]** key.

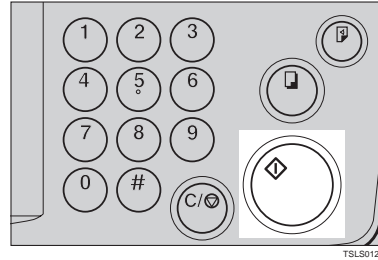

- 4** Check the image position of the trial or proof print.

Note

- If the image position is not correct, adjust it using the **[Image Position]** keys (see ⇒ P.9 “Shifting the Print Image Position Forward or Backward”) or the side tray fine adjusting dial (see ⇒ P.10 “Shifting the Print Image Position to the Right or Left”).

- 5** Enter the number of prints with the number keys.

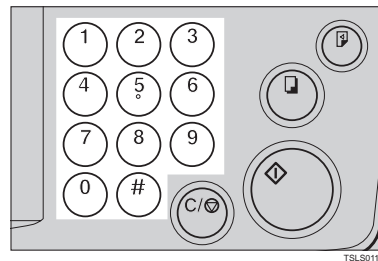

- 6** Make your prints.

1

Program—Storing Your Print Settings in Memory

1

You can store up to 9 frequently used print job settings in machine memory, and recall them for future use.

Note

- ❑ The stored programs are not cleared when you turn off the main switch.
- ❑ The stored programs cannot be deleted. If you want to change a stored program, overwrite it.

Storing Your Settings

1 Set the print settings you want to put into memory.

2 Press the **[Program]** key.

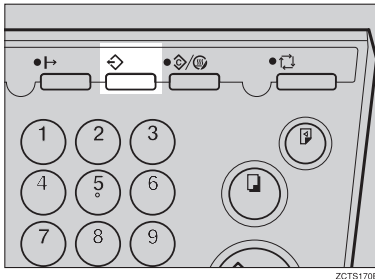

Numbers already containing a program are displayed on the guidance display.

3 Enter "0" with the number key.

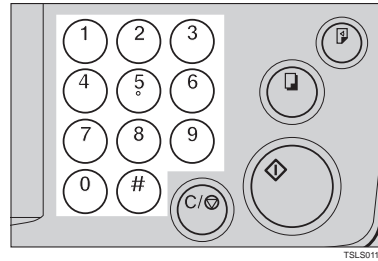

4 Press the **[#]** key.

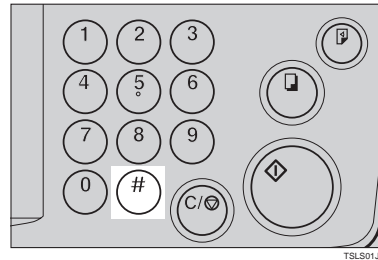

Note

- ❑ The program numbers (1 to 9) will be displayed in the guidance display.
- ❑ If a user program has been protected, that program number will not appear in the display. For how to change a protected user program, see ⇒ P.40 "Protecting a Program".
- ❑ If all the user programs have been protected, the machine returns to the ready condition.

- 5 Select the program number you want to store the settings in with the number keys.

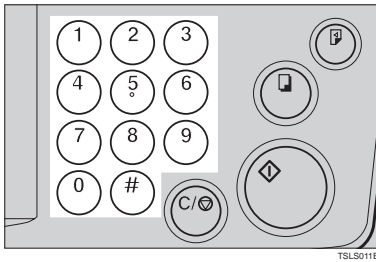

Note

- Make sure that the previous job settings stored under the selected program number are overwritten.

- 6 Press the [#] key.

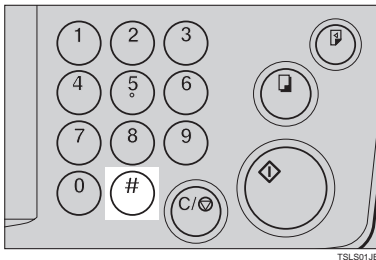

Note

- Numbers already containing a program are displayed on the guidance display.

- 2 Select the program number you want to recall with the number keys.

1

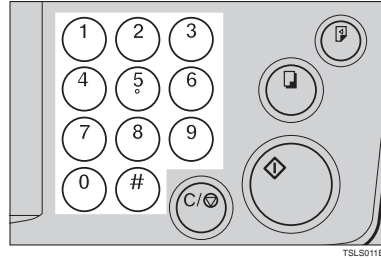

- 3 Press the [#] key.

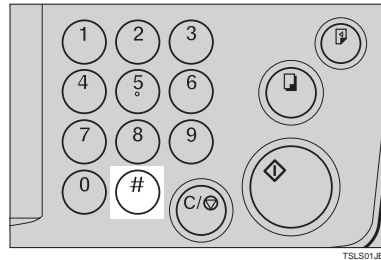

Note

- The stored settings are recalled.

- 4 Set your originals on the exposure glass or in the optional document feeder.

Recalling a Program

- 1 Press the [Program] key.

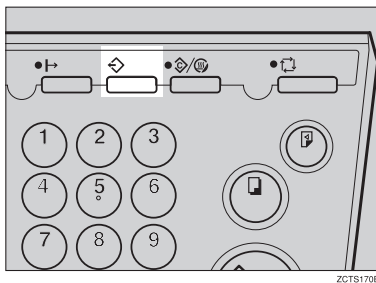

Operation

5 Press the **[Start]** key.

1

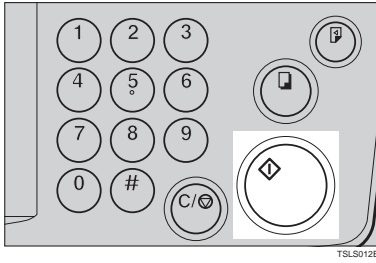

3 Press the **[#]** key.

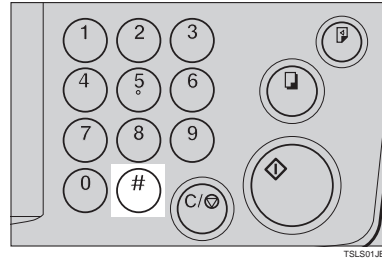

Protecting a Program

If you want to prevent someone from writing over your program, do the following procedure.

1 While holding down the **[Clear/Stop]** key, press the **[Program]** key.

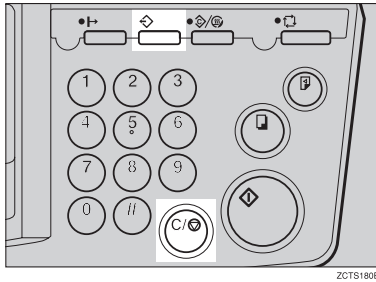

Note

- The numbers of the programs which are not protected will be displayed in the guidance display.

4 Select the program number you want to protect with the number keys.

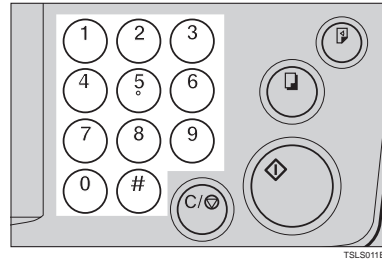

2 Enter "1" with the number keys.

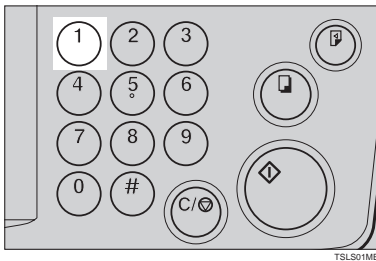

5 Press the **[#]** key.

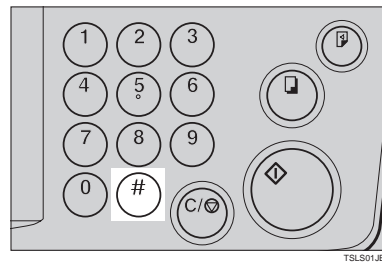

Removing Program Protection

- 1 While holding down the **[Clear/Stop]** key, press the **[Program]** key.

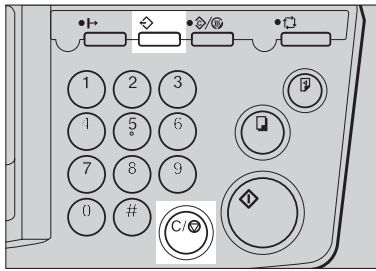

ZCTS180E

- 2 Enter "0" with the number key.

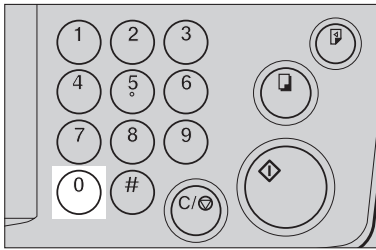

TSL501NE

- 3 Press the **[#]** key.

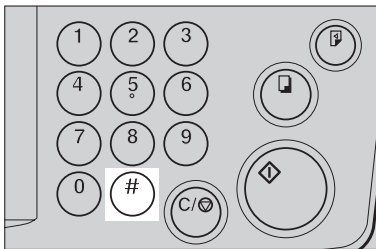

TSL501JE

Note

- If no program number is protected, the machine returns to the ready condition.

- 4 Select the program number you want to remove protection from with the number keys.

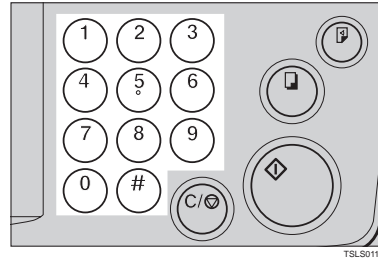

TSL5011E

- 5 Press the **[#]** key.

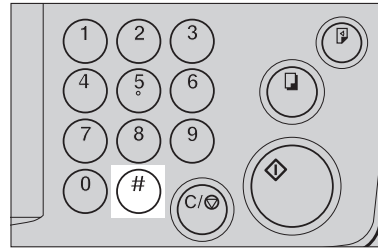

TSL501JE

1

Security Mode—Printing Secret Documents

1

This function prevents others from making prints of secret documents from the master. For example, if you want to print some documents with sensitive information, use this function after making your prints so that nobody can access that master again.

- 1 Make your prints.
- 2 Hold down the **[Security]** key for at least 5 seconds.

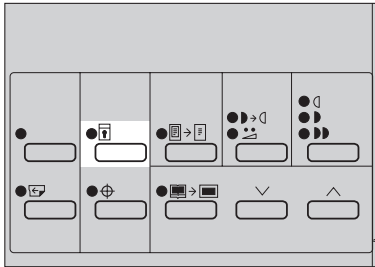

ZCTS190E

Note

- If you press the **[Proof]** key or the **[Print]** key after setting Security mode, the beeper sounds and you cannot make prints.
- You cannot cancel Security mode even if you turn off the main switch.
- If you make the next master, Security mode is canceled.

2. Optional Functions

Printing Using the Optional 30 Originals Document Feeder

Insert a stack of originals in the document feeder. They will be fed automatically.

Document Feeder Exterior

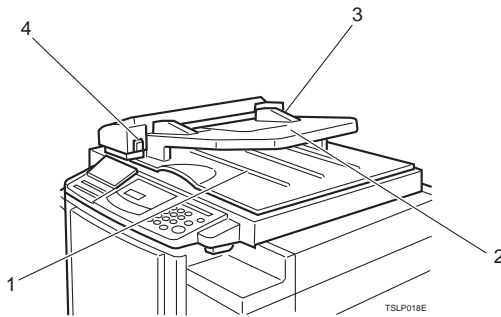

1. Original tray

Original used to make masters are delivered to this tray.

2. ADF unit

Feeds the original to the master making position.

3. Original guides

Adjust these guides to position the originals correctly.

4. ADF unit open lever

Use to open the ADF unit.

Optional Functions

Originals

Setting the following originals in the document feeder might cause original mis-feeds or damage to the originals.

Set these originals on the exposure glass.

2

- Originals heavier than $90\text{g}/\text{m}^2$, 23.9 lb (when setting a stack of originals)
- Originals lighter than $50\text{g}/\text{m}^2$, 13.3 lb (when setting a stack of originals)
- Originals heavier than $120\text{g}/\text{m}^2$, 31.9 lb (when setting one original at a time)
- Originals lighter than $40\text{g}/\text{m}^2$, 10.6 lb (when setting one original at a time)
- Carbon coated originals
- Damaged originals
- Originals with glue on them
- Originals perforated for ring binders
- Book originals
- Originals written with a pencil or ball-point pen
- Originals smaller than $148\text{mm} \times 105\text{mm}$, $5.8" \times 4.1"$
- Originals larger than $257\text{mm} \times 364\text{mm}$, $10.2" \times 14.4"$
- Folded, curled, creased originals
- Bound, stapled, or clipped originals
- OHP transparencies
- Translucent paper
- Pasted originals

Note

- If you use paste-up originals, make sure the pasted parts hold firmly to the base sheet and press the **[Paste Shadow Erase]** key. If the thickness of the paste-up original is more than 0.1mm, and the space between the pasted parts is less than 2mm, 0.08", a shadow might appear on the prints.
- The first 5mm, 0.2", of the leading edge cannot be printed. Make sure the leading edge margin is at least 5mm, 0.2".

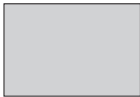
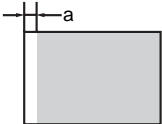
Original	Print
	

- a: 5mm, 0.2"

Setting Originals in the Document Feeder

Note

- ❑ If you set one original into the document feeder while another original is still on the exposure glass, the original set into the document feeder will be scanned first.

1 Adjust the guide to the original size.

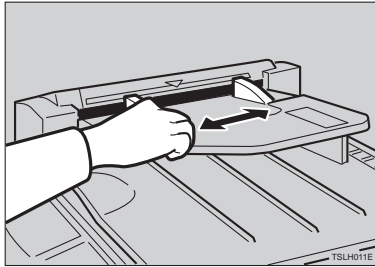

2 Insert the aligned originals face up in the document feeder until they stop.

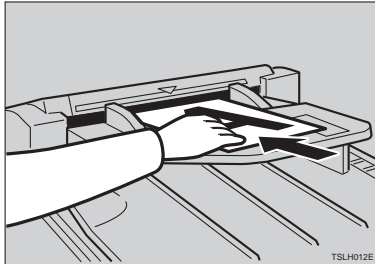

Limitation

- ❑ Approximately 30 originals (64g/m², 17 lb) can be inserted at one time in the 30 originals document feeder. The first (top) original will be fed first.

Note

- ❑ Do not insert different size originals at the same time.
- ❑ The guides must fit snugly against both sides of the stack.

Optional Functions

- 3** Set the desired settings and press the **[Start]** key.

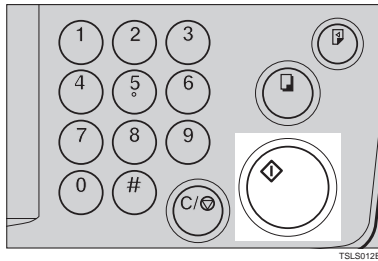

- 4** Make your prints.

Note

- If the next original has been set in the document feeder before the machine stops, that original is fed automatically and a trial print is delivered to the paper delivery tray after the print of the first original is completed. Check the image position of the trial print of the next original. If necessary, make proof prints using the **[Proof]** key to check the image position again.

Combine Copies with the Document Feeder

- 1** Insert the 2 originals face up, tops pointing towards the operation side.

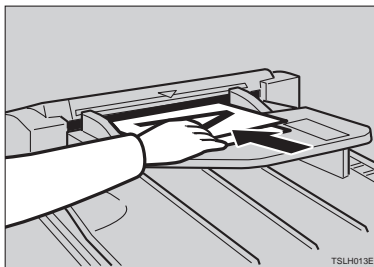

Note

- When you use the optional 30 originals document feeder, the bottom original will be printed on the leading part of print.

- 2** Check the print paper size and the reproduction ratio.

3 Press the **[Combine]** key to select your desired mode.

Reference

For the details of this function, See ⇒ P.33 “Combine—Combining 2 Originals onto One Print”.

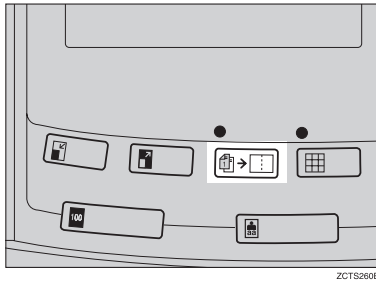

2

4 Press the **[Start]** key.

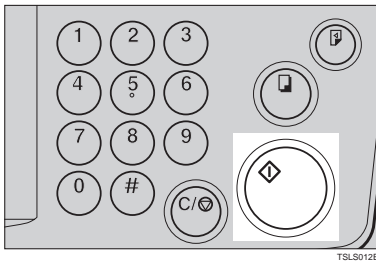

5 Check the image position of the trial or proof print.

Note

- If the image position is not correct, adjust it using the **[Image Position]** keys (see ⇒ P.9 “Shifting the Print Image Position Forward or Backward”) or the side tray fine adjusting dial (see ⇒ P.10 “Shifting the Print Image Position to the Right or Left”).
- After the first original is on the master, the second original is fed.
- If you set only one original, the beeper sounds after the first original is on the master. Set the second original and the desired image settings. Then, press the **[Start]** key.

Optional Functions

6 Enter the number of prints with the number keys.

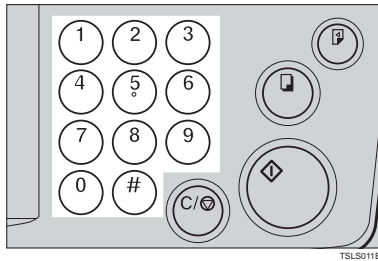

7 Make your prints.

Memory Mode with the Document Feeder

Note

- To prevent original misfeeds, do not set originals of different sizes.
- Do not set more than 30 originals at one time in the optional 30 originals document feeder.

1 Press the **[Memory/Class]** key to light the Memory indicator.

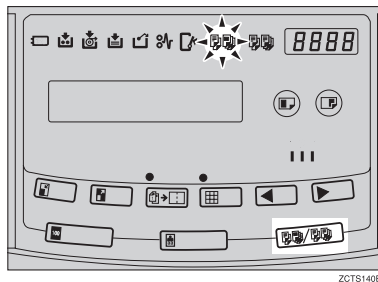

2 With the number keys, enter the desired number of prints for the first original.

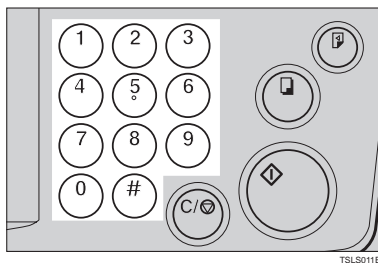

3 Press the **[#]** key.

This stores the number of prints to be made for the first original in memory 1.

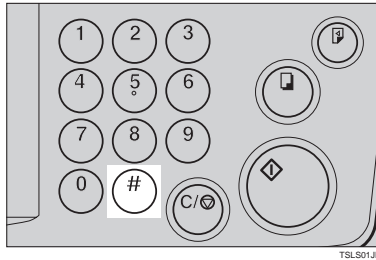

2

Note

- When the number of prints in each set is the same, it is not necessary to input the number of prints for each group in memory. Simply select Auto Cycle mode and enter the desired number of prints once.

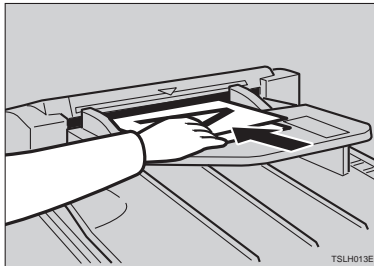
4 Set your originals face up into the document feeder.**Note**

- When you use the optional 30 originals document feeder, the originals are fed from the bottom of the stack. Make sure that the originals are set in the correct sequence with the first original on the bottom.

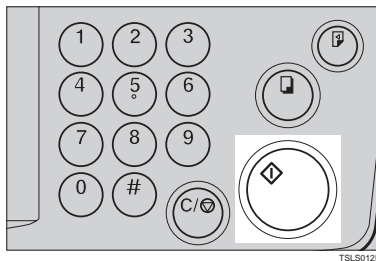
5 Press the **[Start]** key.

Optional Functions

6 Check the image position of the trial or proof print.

Note

- If the image position is not correct, adjust it using the **[Image Position]** keys (see ⇒ P.9 “Shifting the Print Image Position Forward or Backward”) or the side tray fine adjusting dial (see ⇒ P.10 “Shifting the Print Image Position to the Right or Left”).

2

7 Turn on the optional tape dispenser power switch.

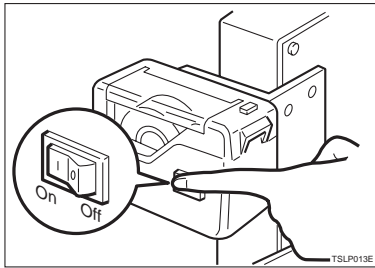

8 Press the **[Auto Cycle]** key.

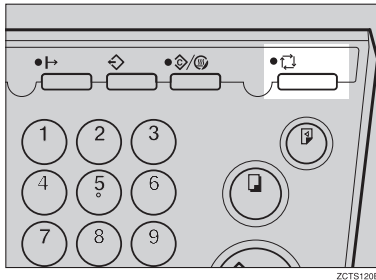

Note

- In Auto Cycle mode, printing starts automatically after a trial print is delivered.

9 Press the **[Print]** key.

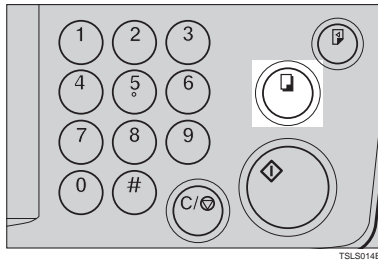

2

Note

- ❑ After the last page of each set is fed out to the paper delivery tray, the tape dispenser drops a strip of paper on the top of the paper stack. The next cycle begins.

Optional Functions

Colour Printing Using the Optional Colour Drum

2

Colour drum units (red, blue, green, brown, yellow, purple, navy, maroon, orange, teal and gray) are available as options in addition to the standard black unit. For making colour prints, a separate drum unit is necessary for each colour.

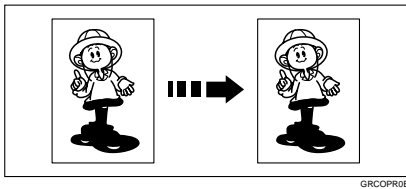

Making Colour Prints

- 1 Make sure that the COLOUR is shown in the guidance display.
- 2 Press the **[Start]** key.

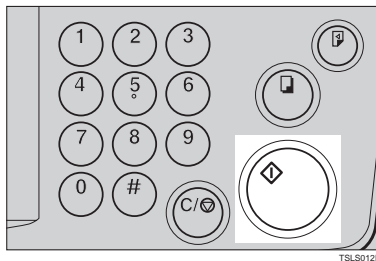

- 3 Check the image position of the trial or proof print.

Note

- If the image position is not correct, adjust it using the **[Image Position]** keys (see ⇒ P.9 "Shifting the Print Image Position Forward or Backward") or the side tray fine adjusting dial (see ⇒ P.10 "Shifting the Print Image Position to the Right or Left").

- 4 Make your prints.

Changing the colour Drum Unit

- 1 Open the front door.



- 2 Lift the lock lever until it locks in position.

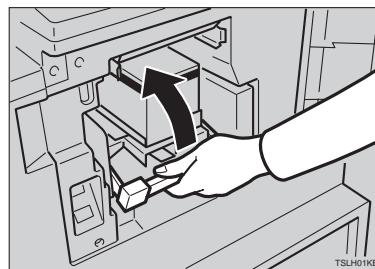

3 Pull out the drum unit handle.

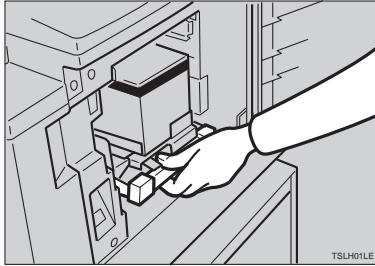

Note

- If you cannot pull out the drum unit, push the drum unit handle, then pull out the drum unit.

4 Hold the rail on the drum and slide out the drum while pulling the release towards you.

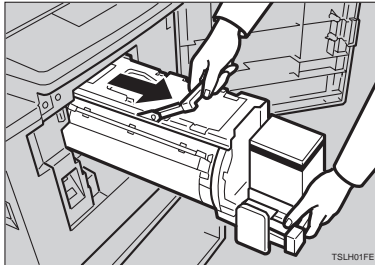

5 Remove the drum unit from the machine while holding the upper drum stay.

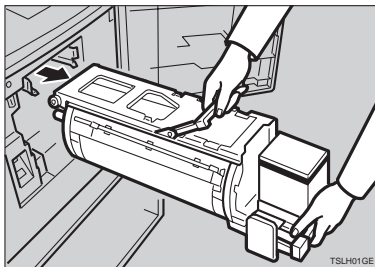

Note

- Be careful not to let the drum unit fall.

6 Insert the colour drum unit along the guide rail.

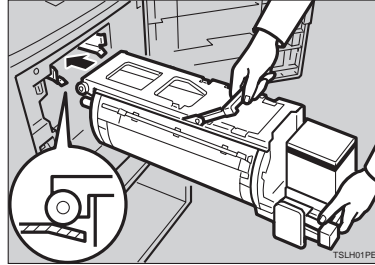

2

7 Slide in the drum unit until it locks in position.

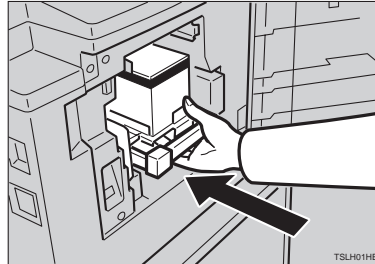

8 Lower the drum unit lock lever.

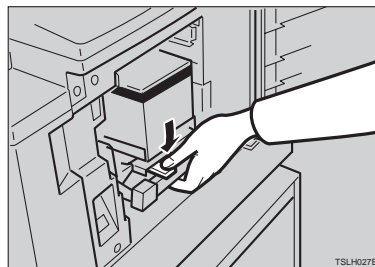

9 Close the front door.

Note

- Make sure that the **Cover Open** indicator (□*) turns off, and the **COLOUR** is shown in the guidance display.

Optional Functions

Printing in Two colours

After printing in one colour, you can print in another colour on the same side of the print.

2

Important

- Leave the prints for a while before printing on them again to let the ink dry.
- If the prints are not dry, the paper feed roller might become dirty. In this case, wipe off the roller with a cloth.

Note

- You cannot print in two colours at one time.

- 1** Prepare the two originals. Set the first original on the exposure glass.

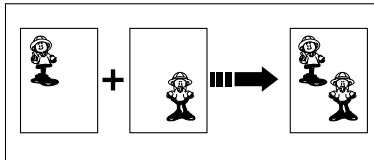

GRPREPOE

- 2** Press the **[Start]** key.

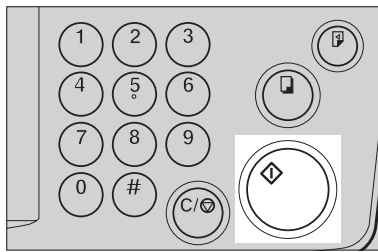

TSL5012E

- 3** Check the image position of the trial or proof print.

Note

- If the image position is not correct, adjust it using the **[Image Position]** keys (see ⇒ P.9 "Shifting the Print Image Position Forward or Backward") or the side tray fine adjusting dial (see ⇒ P.10 "Shifting the Print Image Position to the Right or Left").

- 4** Enter the number of prints with the number keys.

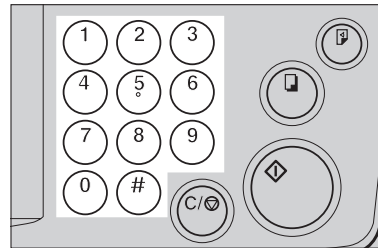

TSL5011E

- 5** Press the **[Print]** key.

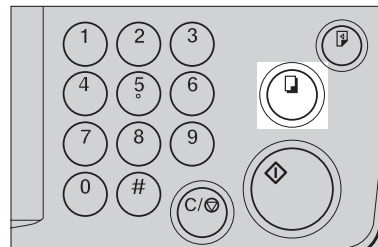

TSL5014E

- Remove the prints from the paper delivery tray and set them on the paper feed tray again as shown in the illustration.

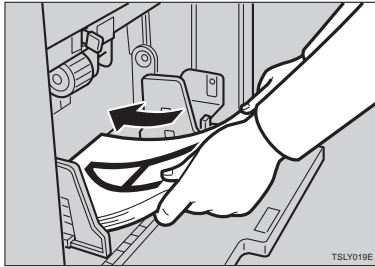

2

- Exchange the drum unit. See ⇒ P.52 "Changing the colour Drum Unit".

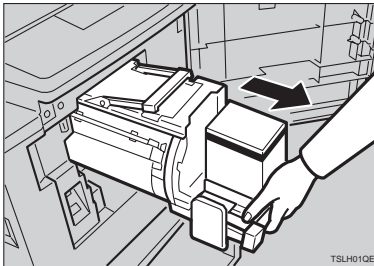

- Set the second original and press the **[Start]** key.

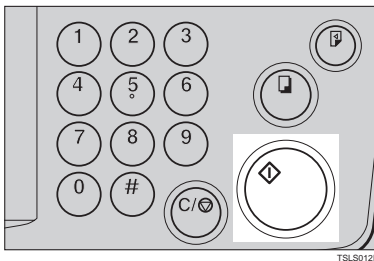

- Check the image position.

- Press the **[Print]** key.

Optional Functions

2

3. Service Program Mode

Accessing Service Programs

The service programs can be set by following this procedure.

Reference

For the service program menu, see ⇒ P.59 "Service Program Menu".

- 1** Press the **[Clear Modes/Energy Saver]** key.

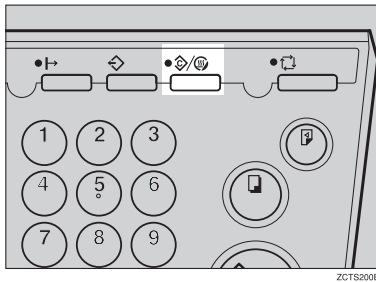

ZCTS200E

- 2** Hold down the **[Clear/Stop]** key for at least 3 seconds.

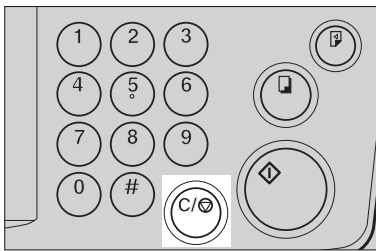

TSL501AE

The SP-mode display appears on the guidance display.

Note

- If you press the wrong key, try pressing the above keys from the beginning.

- 3** With the number keys, enter the desired service program number (SP No.).

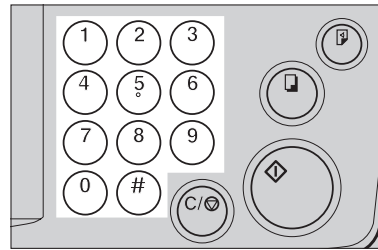

TSL5011E

Reference

For the SP No., see ⇒ P.59 "Service Program Menu".

When you want to leave the service program mode

- 1** Press the **[Clear Modes/Energy Saver]** key.

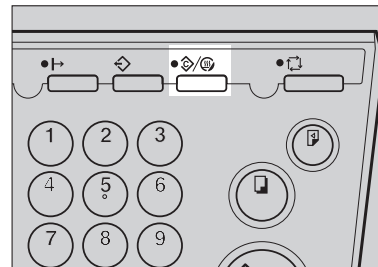

ZCTS200E

Reference

If you want to change the settings of a selected service program, see ⇒ P.58 "Changing the Settings of Service Programs".

Service Program Mode

Changing the Settings of Service Programs

1 After entering the desired SP No., press the **[#]** key.

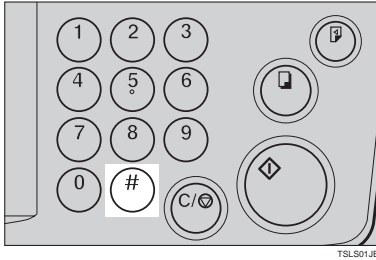

The value or mode set at the factory will be displayed at the end of the second line on the guidance display.

Note

- If you designate the wrong SP No., press the **[Clear Modes/Energy Saver]** key. Then, re-enter the desired SP No.

2 Enter the desired value or mode with the number keys.

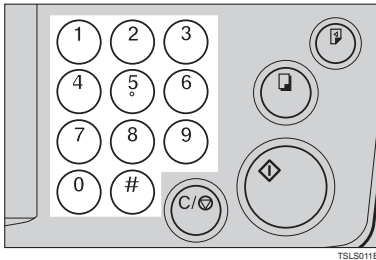

3 Press the **[#]** key to store the desired value or mode.

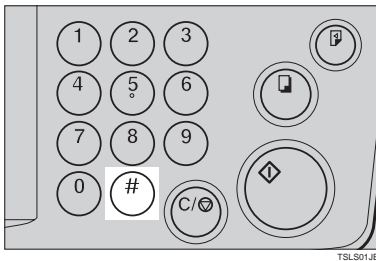

Note

- If you enter the wrong value or mode, press the **[Clear Modes/Energy Saver]** key. Then, go back to step **1**.

When you want to leave the service program mode

① Press the **[Clear Modes/Energy Saver]** key.

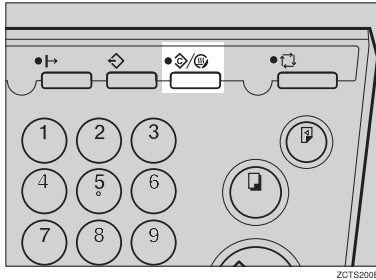









3

Service Program Menu





SP No.	Mode	Function
5	Tape Marker Off	Specifies whether the optional tape dispenser can be used. Note <input type="checkbox"/> Default: 0 <input type="checkbox"/> Adjustment value: 0: No 1: Yes
10	Min. Print	Specifies the minimum number of prints that can be input with the number keys. Note <input type="checkbox"/> Default: 0 <input type="checkbox"/> Adjustment value: 0 to 9999
11	Max. Print	Specifies the maximum number of prints that can be input with the number keys. Note <input type="checkbox"/> Default: 0 <input type="checkbox"/> Adjustment value: 0 to 9999

Service Program Mode



SP No.	Mode	Function
12	Set Language	<p>If you want to change the language used by the guidance display, select the language version.</p> <p> Note</p> <p><input type="checkbox"/> Default: 1</p> <p><input type="checkbox"/> Adjustable value:</p> <ul style="list-style-type: none"> • 0: Japanese • 1: English • 2: German • 3: French • 4: Italian • 5: Spanish • 6: Chinese • 7: Dutch • 8: Portuguese (BRAZIL)
13	Set Size Mode	<p>Change the size mode.</p> <p> Note</p> <p><input type="checkbox"/> Default: 0</p> <p><input type="checkbox"/> Adjustment value: 0: mm 1: Inch</p>
20	Buzzer On	<p>Turns the buzzer ON or OFF.</p> <p> Note</p> <p><input type="checkbox"/> Default: 0</p> <p><input type="checkbox"/> Adjustment value: 0: No 1: Yes</p>
21	Prints/Master Cost	<p>The optional key counter usually counts the number of prints made regardless of the number of masters used. For accounting purposes, it is possible for the key counter to be incremented by a value between 0 and 50 whenever a new master is used.</p> <p>Example: The key counter is adjusted to increase by 20 for each master fed. If 100 copies have been made and the master is replaced, the key counter will increase by 120.</p> <p> Note</p> <p><input type="checkbox"/> Default: 0</p> <p><input type="checkbox"/> Adjustment value: 0 – 50</p>

SP No.	Mode	Function
25	Clear 2 In 1	<p>By default, when master making is finished in Combine Copies mode, this mode stays selected for the next master making.</p> <p>If you want master making turned off, select "1".</p> <p> Note</p> <ul style="list-style-type: none"> <input type="checkbox"/> Default: 0 <input type="checkbox"/> Adjustable value: 0: No 1: Yes <input type="checkbox"/> Even if you select "1" in this mode, Combine Copies mode is not cleared when the next original are set in the optional document feeder. <input type="checkbox"/> For details about Combine Copies, see ⇒ P.33 "Combine—Combining 2 Originals onto One Print".
29	Pht Backgrnd Correct	<p>When you make prints in Photo or Letter/Photo mode, the background of the prints might become dirty. You can prevent this using this function.</p> <p> Note</p> <ul style="list-style-type: none"> <input type="checkbox"/> Default: 0 <input type="checkbox"/> Adjustment value: 0: No 1: Yes
40	Original	<p>Specifies the image mode at power on.</p> <p> Note</p> <ul style="list-style-type: none"> <input type="checkbox"/> Default: 0 <input type="checkbox"/> Adjustment value: <ul style="list-style-type: none"> • 0: Letter mode • 1: Letter/Photo mode • 2: Photo mode
41	Image density	<p>Specifies the image density at power on.</p> <p> Note</p> <ul style="list-style-type: none"> <input type="checkbox"/> Default: 1 <input type="checkbox"/> Adjustment value: <ul style="list-style-type: none"> • 0: Light • 1: Standard • 2: Dark • 3: Darker







Service Program Mode







SP No.	Mode	Function
42	Print Speed	<p>Specifies the printing speed at power on.</p> <p> Note</p> <p><input type="checkbox"/> Default: 2</p> <p><input type="checkbox"/> Adjustment value:</p> <ul style="list-style-type: none"> • 1: 80 sheets/minute • 2: 100 sheets/minute • 3: 130 sheets/minute
43	Auto Cycle Mode	<p>Specifies whether Auto Cycle mode is selected at power on.</p> <p> Note</p> <p><input type="checkbox"/> Default: 1</p> <p><input type="checkbox"/> Adjustment value: 0: No 1: Yes</p>
81	Quality Start No.	<p>You can select how many times Quality Start mode is carried out for each master making.</p> <p>When you set the Quality Start function, the bold letter or solid images might be light.</p> <p> Note</p> <p><input type="checkbox"/> Default: 1</p> <p><input type="checkbox"/> Adjustment value: 0 to 3 times</p>
82	Skip Feed No.	<p>When you use the Skip Feed Printing function, you can select how many times the drum rotates while one sheet of paper is fed.</p> <p> Note</p> <p><input type="checkbox"/> Default: 2 times</p> <p><input type="checkbox"/> Adjustment value: 1 to 9 times</p>
84	Auto Multi copy	<p>If you set an original on the exposure glass and press the [Combine] key and [Start] key, two identical images are printed on the one sheet.</p> <p> Note</p> <p><input type="checkbox"/> Default: 0</p> <p><input type="checkbox"/> Adjustment value: 0: No 1: Yes</p> <p><input type="checkbox"/> For details about Combine, see ⇒ P.33 "Combine—Combining 2 Originals onto One Print".</p>

3

SP No.	Mode	Function
87	Memory Print	<p>Each print set or stack will contain the number of prints you program in Memory mode. If set to Memory, Memory mode will work. If set to Stack, Stack mode will work.</p> <p> Note</p> <ul style="list-style-type: none"> <input type="checkbox"/> Default: 0 <input type="checkbox"/> Adjustment value: 0: Memory 1: Stack <input type="checkbox"/> For details about Memory mode, see ⇒ P.30 "Memory Mode—Group Printing from Different Originals".
88	Auto Memory/ Class	<p>In this function, the machine stops printing for 2 seconds after one set of prints are completed in Memory mode and Class mode. This gives you the chance to separate each set when you do not have an optional tape dispenser.</p> <p>For example, you can remove prints one by one from the paper delivery tray or insert one sheet of paper between the prints.</p> <p> Note</p> <ul style="list-style-type: none"> <input type="checkbox"/> Default: 0 <input type="checkbox"/> Adjustment value: 0: No 1: Yes
113	Resettable Count	<p>Used to display the total number of masters and prints.</p> <ul style="list-style-type: none"> • M: Total number of masters • P: Total number of prints
114	CLR Resettable Count	<p>Clears the resettable master/print counter.</p> <p> Note</p> <ul style="list-style-type: none"> <input type="checkbox"/> Default: 0 <input type="checkbox"/> Adjustment value: 0: No 1: Yes

Service Program Mode

SP No.	Mode	Function
120	User Code Mode	<p>Selects user code mode. When you set this function, you have to also specify the auto reset time. For details about user code mode, see ⇒ P.66 "User Codes".</p> <p> Note</p> <p><input type="checkbox"/> Default:</p> <ul style="list-style-type: none"> • User Code mode: 0 • Auto Reset time: 0 <p><input type="checkbox"/> Adjustment value:</p> <ul style="list-style-type: none"> • User Code mode: 0: No 1: Yes • Auto Reset time: 0: No, 1 – 5 minutes
121	UC Count	<p>Displays the number of masters and prints made in each user code.</p> <p> Note</p> <p><input type="checkbox"/> M: Number of masters</p> <p><input type="checkbox"/> P: Number of prints</p>
122	Clear UC Count	<p>Clear each user code counter.</p> <p> Note</p> <p><input type="checkbox"/> Default: 0</p> <p><input type="checkbox"/> Adjustment value: 0: No 1: Yes</p>
123	Total UC Count	<p>Display the total number of masters and prints for all the 20 user codes.</p> <p> Note</p> <p><input type="checkbox"/> M: Number of masters</p> <p><input type="checkbox"/> P: Number of prints</p>
124	Clear Total UC Count	<p>Clear the total user code counter.</p> <p> Note</p> <p><input type="checkbox"/> Default: 0</p> <p><input type="checkbox"/> Adjustment value: 0: No 1: Yes</p>
125	Auto Energy Saving	<p>You can set the time until the Energy Saver mode starts.</p> <p> Note</p> <p><input type="checkbox"/> Default: 3 Min. (minutes)</p> <p><input type="checkbox"/> Adjustment value: 0: No, 1 – 120: Min</p>

SP No.	Mode	Function
160	Side Ers.	<p>Adjust the default side edge margin width in Edge Erase and Centre/Edge Erase mode.</p> <p> Note</p> <p><input type="checkbox"/> Default:</p> <ul style="list-style-type: none"> • Metric Version: 5mm • Inch Version: 0.2" <p><input type="checkbox"/> Adjustable value:</p> <ul style="list-style-type: none"> • Metric Version: 2 – 20mm • Inch Version: 0.1" – 0.8"
161	Center Ers.	<p>Adjust the default Centre margin width in Centre/Edge Erase mode.</p> <p> Note</p> <p><input type="checkbox"/> Default:</p> <ul style="list-style-type: none"> • Metric version: 10mm • Inch version: 0.4" <p><input type="checkbox"/> Adjustable value:</p> <ul style="list-style-type: none"> • Metric version: 4 – 60mm • Inch version: 0.2" – 2.3"
162	Horizontal Ers.	<p>Adjust the default horizontal edge (top and bottom) margin in Edge Erase and Centre/Edge Erase mode.</p> <p> Note</p> <p><input type="checkbox"/> Default:</p> <ul style="list-style-type: none"> • Metric version: 5mm • Inch version: 0.2" <p><input type="checkbox"/> Adjustable value:</p> <ul style="list-style-type: none"> • Metric version: 2 – 20mm • Inch version: 0.1" – 0.8"
170-172	Ers.**1  Ers.**2  Ers.**3 	<p>Set up and register three original sizes for when performing edge erase of non-standard size originals, or performing centre frame erase.</p> <p> Note</p> <p><input type="checkbox"/> Default: 0 × 0mm</p> <p><input type="checkbox"/> Adjustable value: 100-257mm × 100-364mm</p>

Entering decimal values in SP No. 160–162:

- Press the **[Program]** key to enter a decimal point.
- Press the **[#]** key to fix the value.

Service Program Mode

User Codes

If the machine is set to use the User Code function, operators must input their user codes before the machine can operate. The machine keeps count of the number of prints made under each user code.

In this mode, the following 20 user codes (fixed) can be used to access the machine: 382, 191, 182, 173, 164, 155, 146, 137, 128, 119, 482, 291, 282, 273, 264, 255, 246, 237, 228, 219

3

Note

- ❑ To prevent unauthorized users from accessing the machine, note down the codes and then black out the codes from this manual.

How to Set User Code Mode (# 120)

The following procedure explains how to set user code mode. This must be done before a user code can be input.

- 1 Press the **[Clear Modes/Energy Saver]** key.

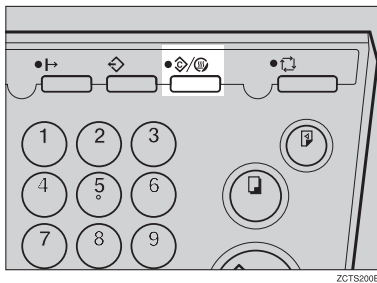

- 2 Hold down the **[Clear/Stop]** key for at least 3 seconds.

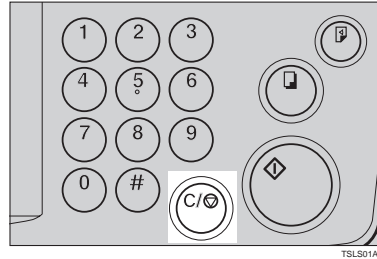

- 3 Enter "120" with the number keys and press the **[#]** key.

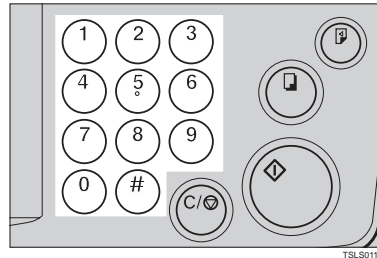

- 4 Enter "1" (Yes) with the number keys and then press the **[#]** key.

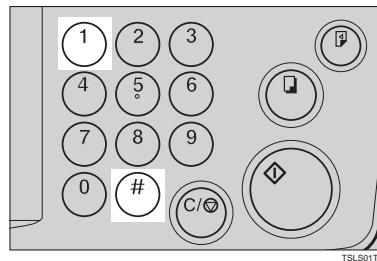

- 5** Specify the Auto Reset time. Enter the desired setting with the number keys and press the **[#]** key.

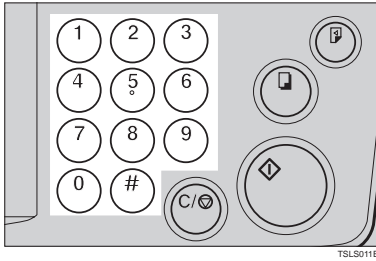

- 6** Press the **[Clear Modes/Energy Saver]** key to leave Service Program mode.

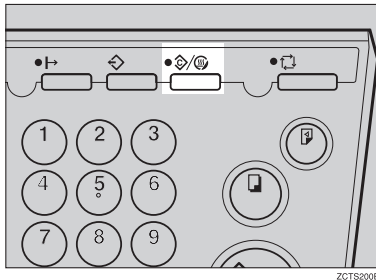

How to Use User Code Mode

- 1** Input your assigned 3-digit user code with the number keys, then press the **[#]** key.

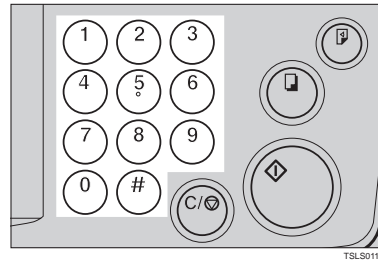

3

- 2** Make your prints.
- 3** After you have finished, press the **[Clear/Stop]** key while holding down the **[Clear Modes/Energy Saver]** key.

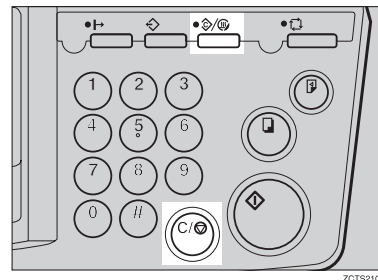

Note

- This prevents others from making prints using your user code.
- If you do not follow this step, the machine will not request the next user for their codes unless the auto reset time has expired.

Service Program Mode

How to Check the User Code Counter (# 121)

Reference

If you want to check the total masters and prints made under all user codes, see ⇒ P.70 "How to Check the Total Number of Masters and Prints Made Under All User Codes (# 123)".

3

- 1 Press the **[Clear Modes/Energy Saver]** key.

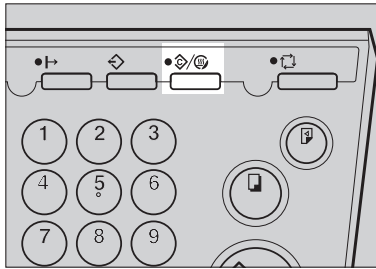

ZCTS200E

- 2 Hold down the **[Clear/Stop]** key for at least 3 seconds.

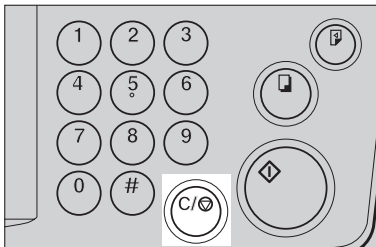

TSL501AE

- 3 Enter "121" with the number keys and press the **[#]** key.

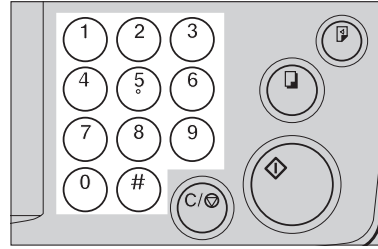

TSL5011E

The number of masters and prints made under the user code "382" will be displayed in the guidance display.

- 4 Keep pressing the **[#]** key to display the number of masters and prints made under your user code.

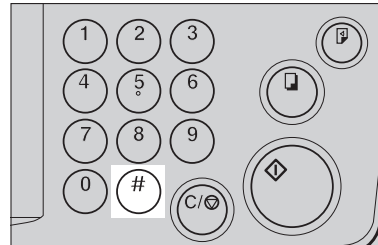

TSL5011E

- 5 Press the **[Clear Modes/Energy Saver]** key to leave Service Program mode.

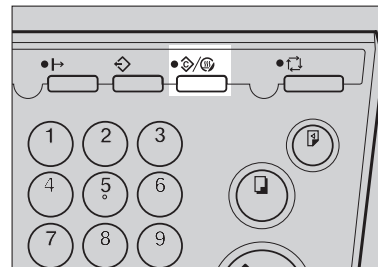

ZCTS200E

How to Clear the User Code Counter (# 122)

Reference

If you want to clear every user code counter, see ⇒ P.71 "How to Clear the User Code Total Counter (# 124)".

- 1 Press the **[Clear Modes/Energy Saver]** key.

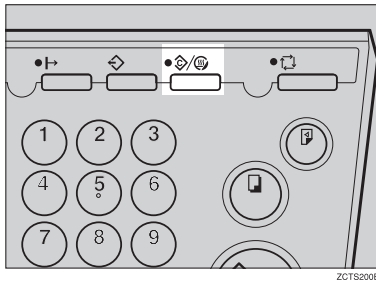

ZCTS000E

- 2 Hold down the **[Clear/Stop]** key for at least 3 seconds.

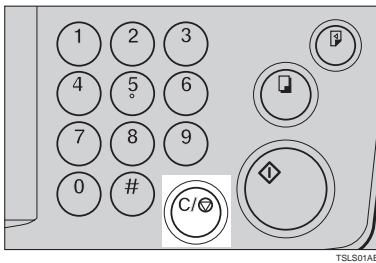

TSL501AE

- 3 Enter "122" with the number keys and press the **[#]** key.

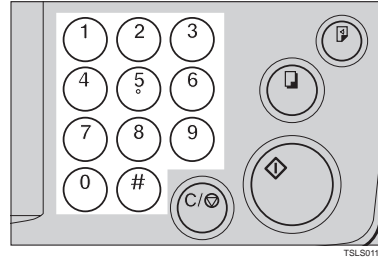

TSL5011E

3

- 4 Keep pressing the **[#]** key until desired user code is displayed.

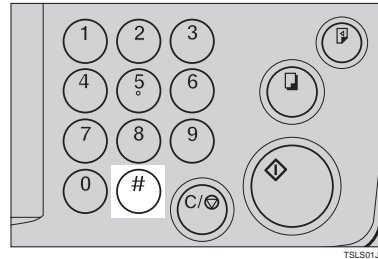

TSL501JE

- 5 Enter "1" (Yes) with the number keys and press the **[#]** key.

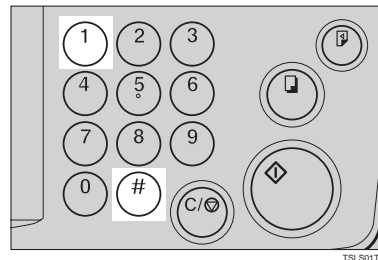

TSL501TE

- 6 Press the **[Clear Modes/Energy Saver]** key to leave Service Program mode.

Service Program Mode

How to Check the Total Number of Masters and Prints Made Under All User Codes (# 123)

1 Press the **[Clear Modes/Energy Saver]** key.

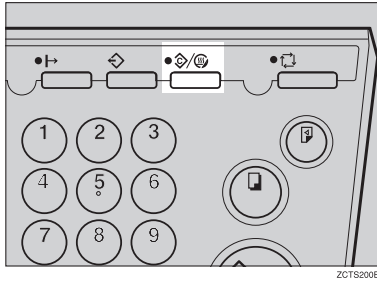

2 Hold down the **[Clear/Stop]** key for at least 3 seconds.

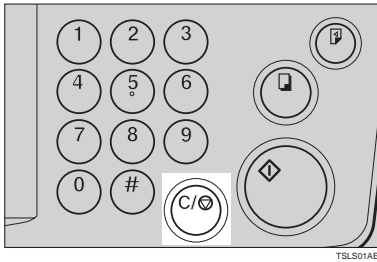

3 Enter "123" with the number keys and press the **[#]** key.

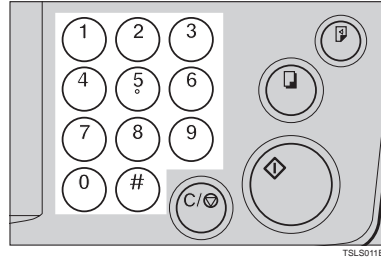

The total number of masters and prints made under all user codes will be displayed in the guidance display.

- M: Number of masters
- P: Number of prints

4 Press the **[Clear Modes/Energy Saver]** key to leave Service Program mode.

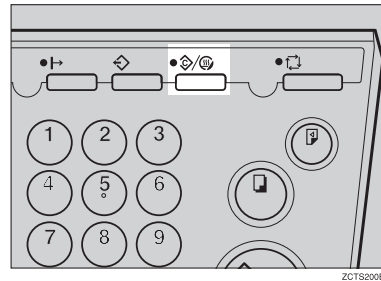

How to Clear the User Code Total Counter (# 124)

- 1** Press the **[Clear Modes/Energy Saver]** key.

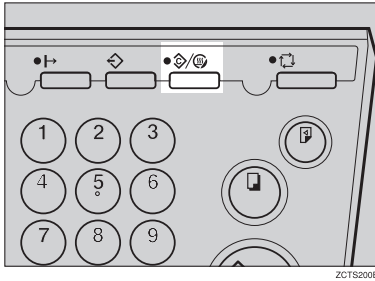

- 2** Hold down the **[Clear/Stop]** key for at least 3 seconds.

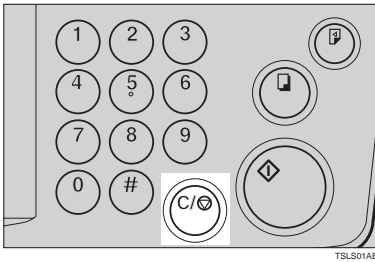

- 3** Enter "124" with the number keys and press the **[#]** key.

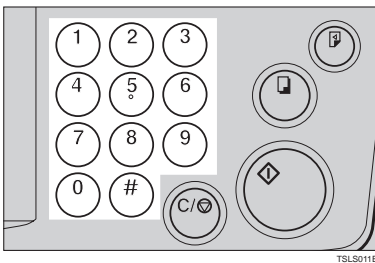

- 4** Enter "1" (Yes) with the number keys and press the **[#]** key.

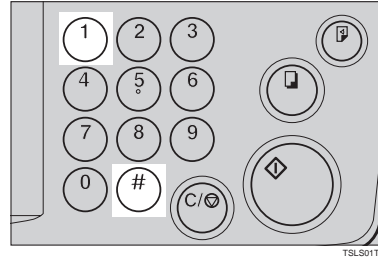

- 5** Press the **[Clear Modes/Energy Saver]** key to leave Service Program mode.

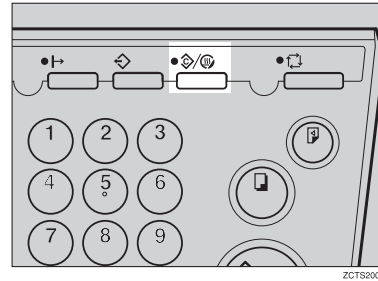

3

Service Program Mode

3

4. Replenishing Supplies

Loading Paper on the Paper Feed Tray

The **Load Paper** indicator (📄) lights when the paper feed tray runs out of paper.

Replenishing Paper

1 Press the **[Clear/Stop]** key.

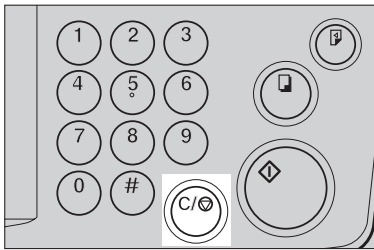

TSL501AE

Note

- ☐ This step is necessary only if you want to pause a print run to replenish paper.

2 Press the **[Paper Feed Tray Down]** key.

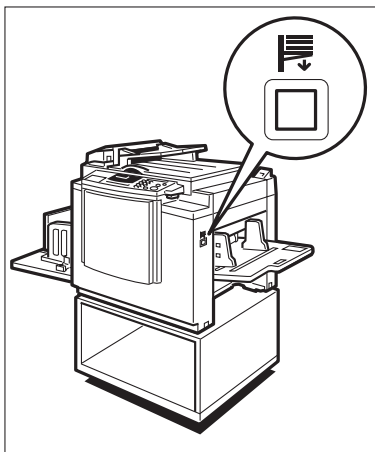

ZCTH070E

Note

- ☐ The paper feed tray will lower without the key being pressed when the printing paper runs out.
- ☐ The top sheet might remain between the feed rollers. In this case, remove the top sheet.

3 Load paper on the paper feed tray.

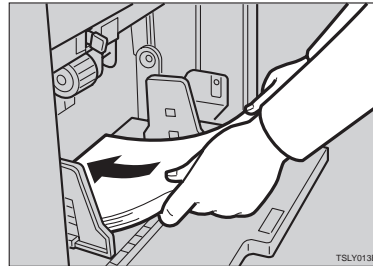

TSLY013E

Note

- ☐ Correct paper curl before setting the paper.

4 Press the **[Print]** key to resume printing.

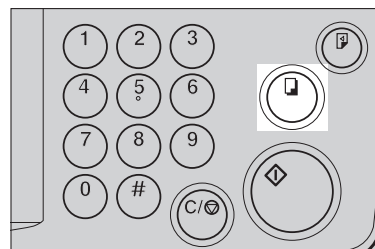

TSL5014E

Replenishing Supplies

Changing the Paper Size

- 1** Remove the paper from the paper feed tray.

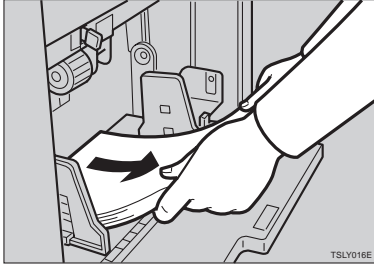

4

The paper feed tray will lower.

- 2** Put the paper feed side plates lock lever. Adjust the paper feed side plates to match the paper size.

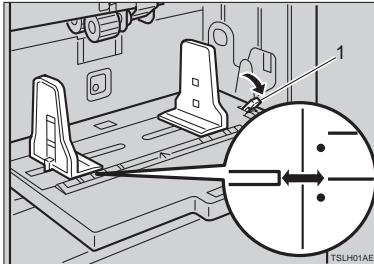

1: Paper Feed Side Plates Lock Lever

- 3** Place the paper on the paper feed tray.

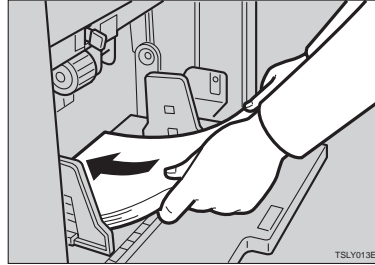

Note

- Correct any paper curl before setting the paper.
- Make sure that the side plates touch the paper lightly.
- Put back the lock lever.

- 4** Adjust the side plates and the end plate.

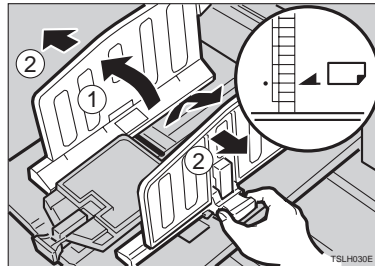

When the Add Ink Indicator (🖨️) Lights

The **Add Ink** indicator (🖨️) lights when it is time to supply ink.

⚠️ CAUTION:

- If ink comes into contact with your eyes, rinse immediately in running water. In the case of any abnormal symptoms, consult a doctor.

⚠️ CAUTION:

- Keep the ink or ink container out of the reach of children.

⚠️ CAUTION:

- If ink is ingested, force vomiting by drinking a strong saline solution and consult a doctor immediately.

⚠️ CAUTION:

- Our products are engineered to meet high standards of quality and functionality, and we recommend that you only use the expendable supplies available at an authorized dealer.

4

1 Open the front door.



2 Pull out the ink holder and remove the used ink cartridge.

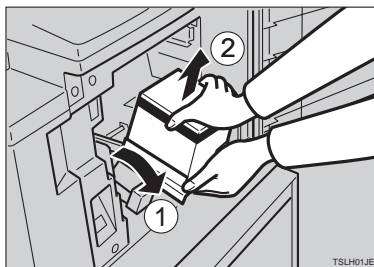

Replenishing Supplies

3 Remove the cap of the new ink cartridge.

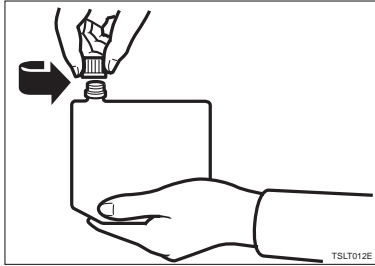

4 Insert the new cartridge into the ink holder.

4

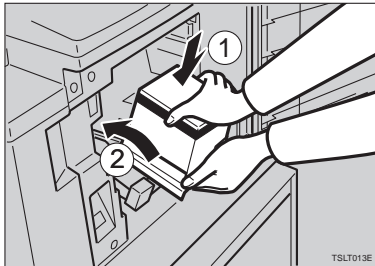

5 Return the ink holder to its original position until it clicks.

Note

- Always supply ink of the same colour.
- Make sure to firmly insert the part indicated by the arrow mark into the guide.

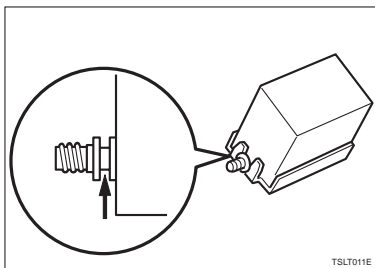

6 Close the front door.

The machine will start idling to supply ink to the drum.

Note

- It will stop when the correct amount of ink reaches the drum.

Master Roll Replacement

The **Master End** indicator (🔦) is lit when it is time to replace the master roll.

1 Open the original tray.

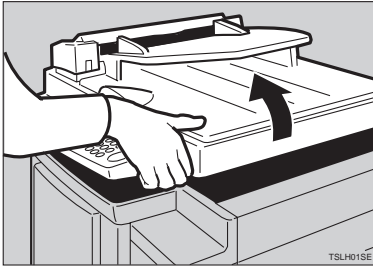

Note

- Lift the original tray release lever and lift the original tray.

2 Open the right side cover.

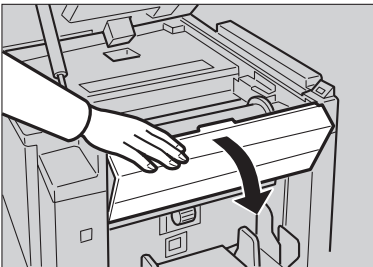

3 Open the plotter cover.



4 Remove the used master roll and pull out both spools. Then, insert both spools into a new master roll.

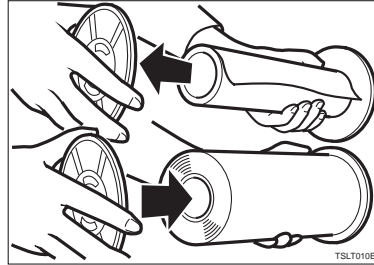

4

Note

- When the **Master End** indicator lights, it is necessary to replace the master roll even if some master remains on the old roll.

5 The new master roll must be positioned as shown in the illustration.

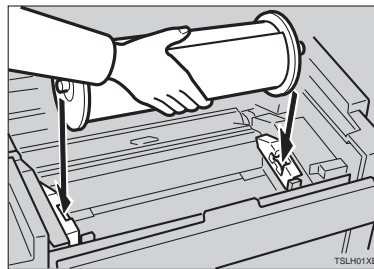

Replenishing Supplies

- 6** Set the paper edge of the master roll as shown.

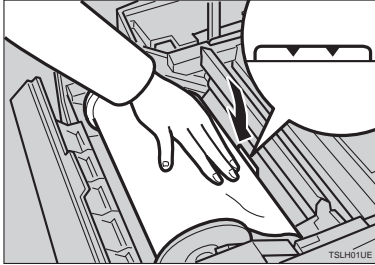

- 9** Return the original tray to its original position.

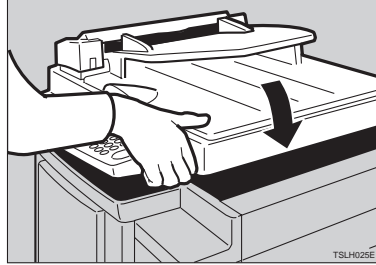

4

Note

- Rotate the spools backward to take up any slack in the master.

- 7** Close the plotter cover.



- 8** Close the right side cover.

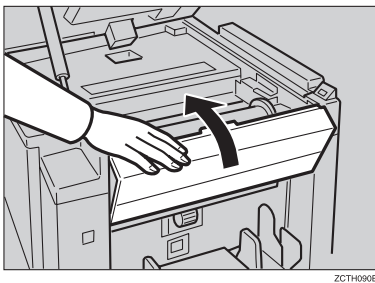

Placing a New Roll of Tape in the Tape Dispenser (Option)

Note

- Make sure that the main switch is turned on and the power switch of the tape dispenser is off.

- 1** Open the cover of the tape dispenser.

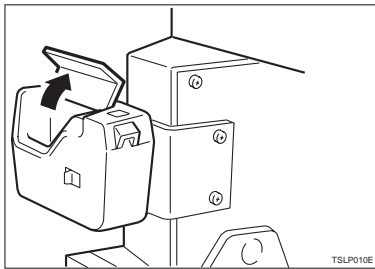

- 2** As shown, put the roll in the dispenser.

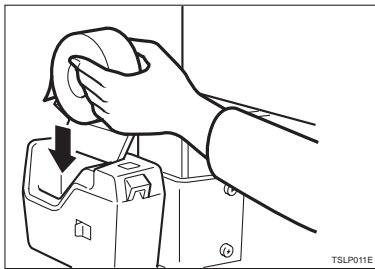

Note

- Make sure that the tape is installed in the proper direction. If it is not in the correct direction, the tape dispenser will not work correctly.

- 3** Feed the leading edge of the roll in the dispensing slot until it stops.

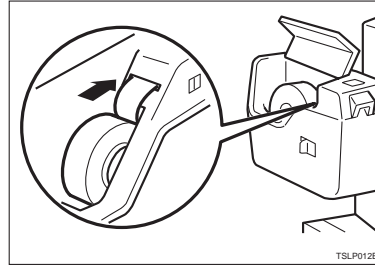

Note

- Push the tape as far as possible through the slot.

- 4** Turn on the power switch of the tape dispenser.

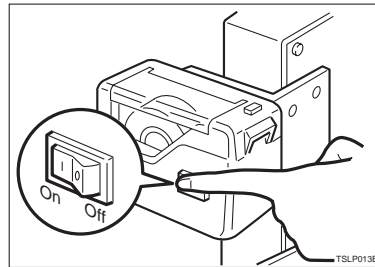

- 5** Press the manual cut button to trim off the leading edge of the tape.

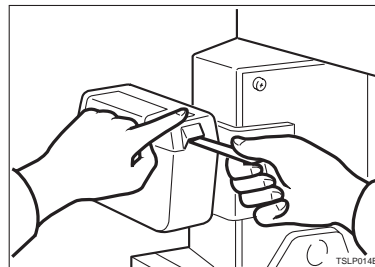

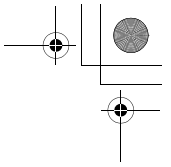
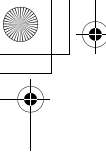

Replenishing Supplies

4

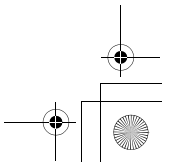
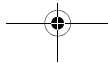
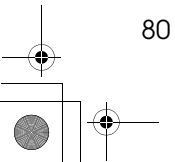
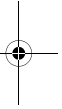
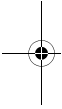

5. What to do If Something Goes Wrong

If Your Machine does not Operate as You Want

If a malfunction or a misfeed occurs within the machine, the following indicators will light.

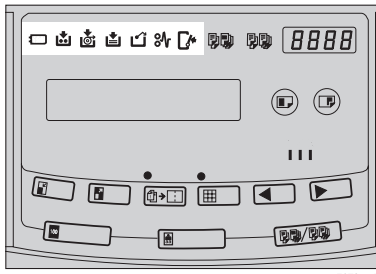

ZCTS220E

◆ When the misfeed indicator (⚡) lights

Indicator	Guidance Display	Page
⚡	ORIGINAL JAM. REMOVE ORIGINAL REMOVE ORIGINAL	⇒ P.84 ““⚡” + “ORIGINAL JAM. REMOVE ORIGINAL””.
⚡	PAPER FEED JAM. REMOVE JAMMED PAPER REMOVE JAMMED PAPER	⇒ P.87 ““⚡” + “PAPER FEED JAM. REMOVE JAMMED PAPER””.
⚡	MASTER FEED JAM. REMOVE JAMMED MASTER REMOVE JAMMED MASTER	⇒ P.90 ““⚡” + “MASTER FEED JAM. REMOVE JAMMED MASTER””.
⚡	PAPER WRAP JAM. REMOVE JAMMED PAPER REMOVE JAMMED PAPER	⇒ P.92 ““⚡” + “PAPER WRAP JAM. REMOVE JAMMED PAPER””.
⚡	MASTER EJECT JAM. REMOVE JAMMED MASTER REMOVE JAMMED MASTER	⇒ P.94 ““⚡” + “MASTER EJECT JAM. REMOVE JAMMED MASTER””.
⚡	DELIVERY JAM. REMOVE JAMMED PAPER REMOVE JAMMED PAPER	⇒ P.96 ““⚡” + “DELIVERY JAM. REMOVE JAMMED PAPER””.

What to do If Something Goes Wrong

⚠ CAUTION:

- *Be careful not to cut yourself on any sharp edges when you reach inside the machine to remove misfed sheets of paper or masters.*

📝 Note

- To prevent misfeeds, do not leave any torn scraps of paper within the machine.
- When clearing misfeeds, do not turn off the main switch. If you do, your copy settings are cleared.
- If misfeeds occur repeatedly, contact your service representative.

❖ When the open cover/unit indicator (🔒) lights

Monitor	Guidance Display and Action	Page
🔒	CLOSE THE COVER <ul style="list-style-type: none"> • Close the original tray unit. • Close the front door. 	⇒ P.97 "When the Open Cover/Unit Indicator (🔒) Lights".
	CLOSE THE PLOTTER COVER <ul style="list-style-type: none"> • Close the right side cover and the plotter cover. 	
	CLOSE THE ADF COVER <ul style="list-style-type: none"> • Close the optional ADF unit. 	⇒ P.97 "When the Open Cover/Unit Indicator (🔒) Lights".
	SET THE DRUM COMPLETELY	

❖ When the supply/exchange indicators light

Monitor	Guidance Display and Action	Page
📄	LOAD MORE PAPER	⇒ P.73 "Loading Paper on the Paper Feed Tray".
🖨	LOAD NEW INK CARTRIDGE	⇒ P.75 "When the Add Ink Indicator (🖨) Lights".
📀	LOAD NEW MASTER ROLL	⇒ P.77 "Master Roll Replacement".
🗑	EMPTY MASTER EJECT BOX <ul style="list-style-type: none"> • Remove the used master. 	⇒ P.99 "When the Master Eject Indicator (🗑) Lights".
	SET THE MASTER EJECT BOX	

❖ When other indicators light

Monitor	Guidance Display and Action	Page
🔑	SET THE KEY COUNTER	⇒ P.100 "When Other Indicators Light".

If Your Machine does not Operate as You Want

❖ **When one of the following messages is displayed on the guidance display**

Guidance Display	Meaning
RE-ENTER COPY NUMBER MAXIMUM IS XXX	The maximum number of prints that can be entered is specified by the Service Program mode. Change the number of prints.
RE-ENTER COPY NUMBER MINIMUM IS XXX	The minimum number of prints that can be entered is specified by the Service Program mode. Change the number of prints.
SET THE ORIGINALS	Make prints after you confirm whether there is an original.
INPUT YOUR ID CODE	User Code mode is set. Before printing, enter your user code.
NO ADDITIONAL PRINTS ALLOWED	Security mode is set. If you make the next master, Security mode is canceled.
MASTER MAKING HALTED	Master making is halted. Press the [Start] key.

5

💡 **When a service code (E-XX) is displayed in the guidance display**

Turn the main switch off and on. If a service code appears again, contact your service representative.

📌 **Note**

- If a service code appears on the guidance display after you turn the main switch off and on a few times, do not continue turning it on and off. Leave the machine off.
- E04 might be displayed when you make masters continuously using the originals that have solid images. In the case, turn off the main switch and wait for a while.

What to do If Something Goes Wrong

🔧 Clearing Misfeeds

⚠️ Important

- ❑ When clearing misfeeds, do not turn off the main switch. If you do, your print settings are cleared.

💡 After clearing misfeeds

Press the **[Clear Modes/Energy Saver]** key to reset the error indicators.

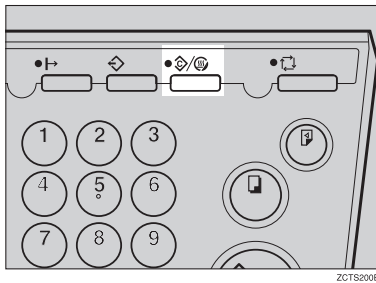

5

“🔧” + “ORIGINAL JAM. REMOVE ORIGINAL”

📝 Note

- ❑ These indicators will light when your machine is equipped with the optional document feeder.

1 Press the ADF unit open lever and open the ADF unit.

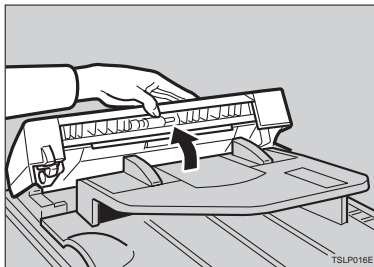

2 Pull out the original gently.

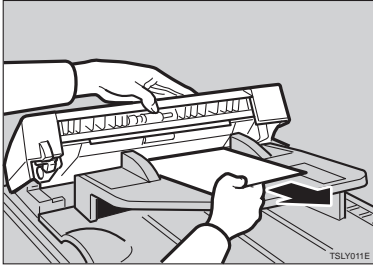

3 If you cannot remove the misfed original, pull out the original from the side of the original tray and remove the original.

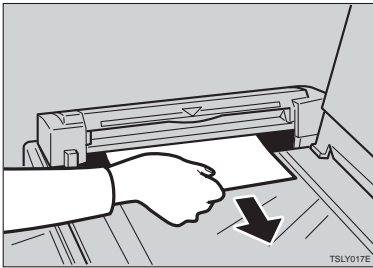

5

4 If you still cannot remove the misfed paper, press the ADF open lever and open the ADF unit to remove the original.

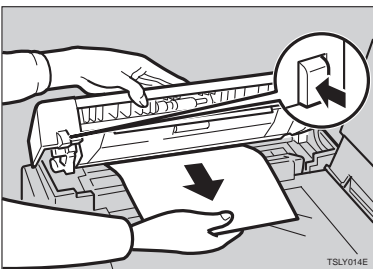

5 Close the ADF unit until it locks in position.

What to do If Something Goes Wrong

To prevent original misfeeds:

- Originals heavier than $90\text{g}/\text{m}^2$, 23.9 lb (when setting a stack of originals)
- Originals lighter than $50\text{g}/\text{m}^2$, 13.3 lb (when setting a stack of originals)
- Originals heavier than $120\text{g}/\text{m}^2$, 31.9 lb (when setting one original at a time)
- Originals lighter than $40\text{g}/\text{m}^2$, 10.6 lb (when setting one original at a time)
- Carbon coated originals
- Damaged originals
- Originals with glue on them
- Originals perforated for ring binders
- Book originals
- Originals written with a pencil or ball-point pen
- Originals smaller than $148\text{mm} \times 105\text{mm}$, $5.8" \times 4.1"$
- Originals larger than $257\text{mm} \times 364\text{mm}$, $10.2" \times 14.4"$
- Folded, curled, creased originals
- Bound, stapled, or clipped originals
- OHP transparencies
- Translucent paper
- Pasted originals

5

Note

- If you use paste-up originals, make sure the pasted parts hold firmly to the base sheet and press the **[Paste Shadow Erase]** key. If the thickness of the paste-up original is more than 0.1mm, and the space between the pasted parts is less than 2mm, 0.08", a shadow might appear on the prints.
- The first 5mm, 0.2" of the leading edge cannot be printed. Make sure the leading edge margin is at least 5mm, 0.2".

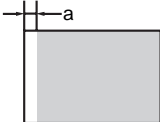
Original	Print
	

- a: 5mm, 0.2"
- Do not mix different sizes of originals in the optional document feeder.
- Clean the separation roller if it is dirty. (A dirty separation roller might slip and cause original misfeeds.)
- Remove staples or clips of originals. Fan originals that have had staples or clips removed.

“” + “PAPER FEED JAM. REMOVE JAMMED PAPER”

CAUTION:

- *Be careful not to cut yourself on any sharp edges when you reach inside the machine to remove misfed sheets of paper or masters.*

Misfeed in the paper feed section

1 Slowly but firmly pull out the paper.

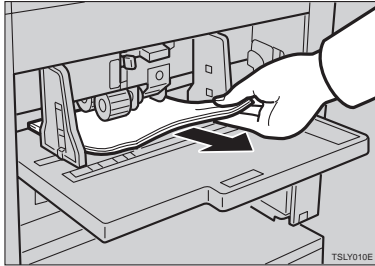

5

Paper is wrapped around the drum

1 Pull out the drum unit.

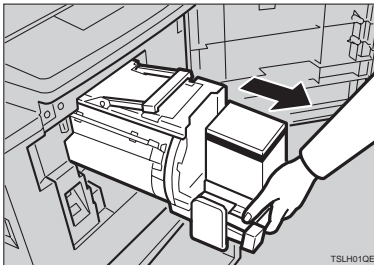

2 Remove the misfed paper.

What to do If Something Goes Wrong

- 3** Re-insert the drum unit until the drum unit locks in position and put the lever back in place.

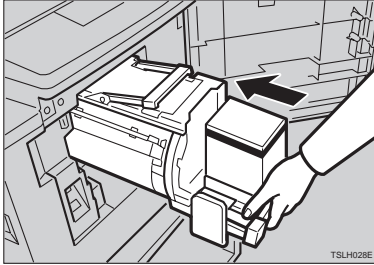

- 4** Close the front door.

5

To prevent paper misfeeds:

If the paper is curled or the originals leading edge margin is too narrow, the following action is necessary.

- When you use curled paper, correct the curl as shown.

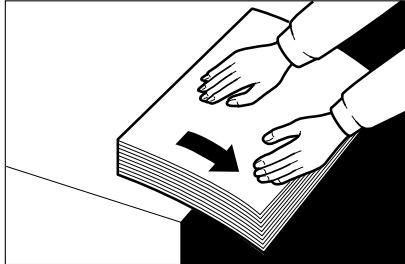

- If you cannot correct the paper curl, stack the paper with the curl face down as shown.

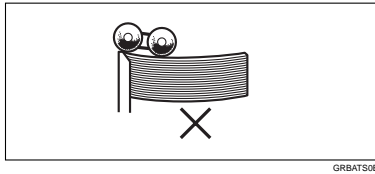
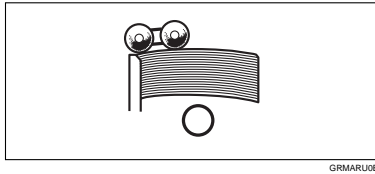

- When the leading edge margin of the original is less than 5mm, 0.2" or there is a solid image on the leading edge, insert the original with the widest margin first or make a leading edge margin by making a copy.

5

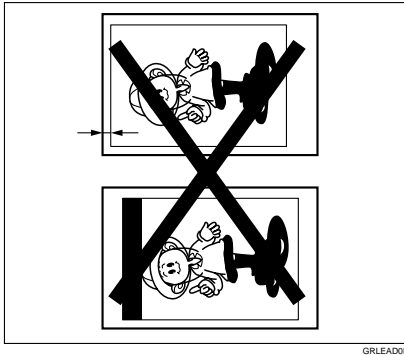

What to do If Something Goes Wrong

“” + “MASTER FEED JAM. REMOVE JAMMED MASTER”

1 Open the original tray.

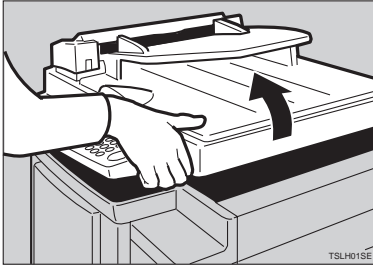

Note

- Lift the original tray release lever and slide the original tray all the way to the left.

5

2 Open the right side cover.

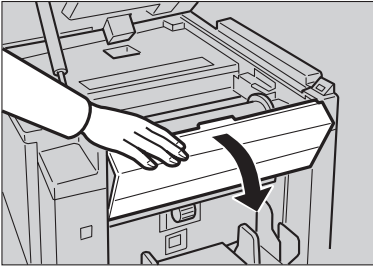

3 Open the plotter cover.



- 4** If you could not remove the misfed master in steps **2** and **3**, take out the drum and remove the misfed master from the inside.

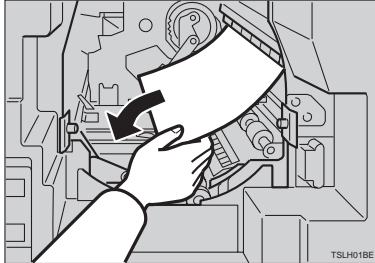

Reference

For how to take out the drum unit, see ⇒ P.52 "Changing the colour Drum Unit".

- 5** If the original misfeeds in the optional document feeder, press the ADF open lever and open the ADF unit to remove the misfed sheet.

5

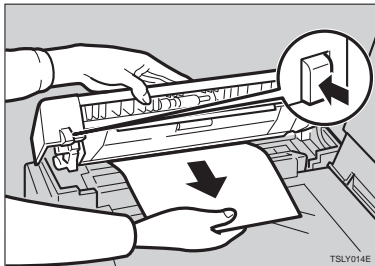

- 6** Return the original tray to its original position.

Note

- If you follow step **4**, set the drum unit and close the front door.
- If you follow step **5**, close the ADF unit.

What to do If Something Goes Wrong

“” + “PAPER WRAP JAM. REMOVE JAMMED PAPER”

CAUTION:

- Be careful not to cut yourself on any sharp edges when you reach inside the machine to remove misfed sheets of paper or masters.

1 Remove the misfeed paper.

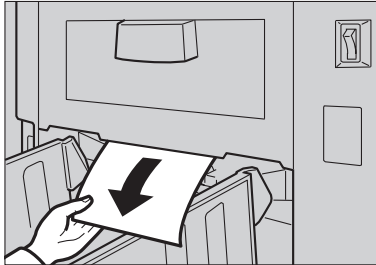

5

2 If the paper is completely wrapped around the drum, pull out the drum unit and remove the misfed paper from the drum.

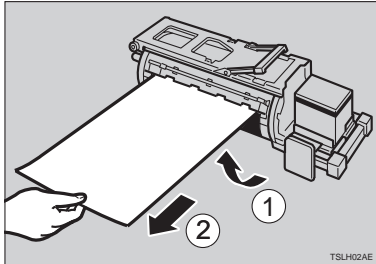

3 Re-install the drum unit locks in position and put the lever back in place.

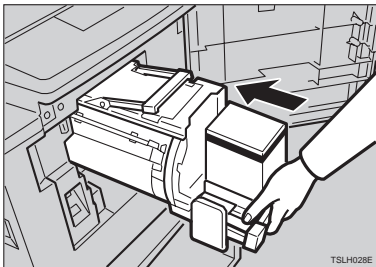

Note

- If you followed step **2** or **3**, close the front door.

To prevent paper misfeeds:

If the paper is curled or the original's leading edge margin is too narrow, the following action is necessary.

- When you use curled paper, correct the curl as shown.

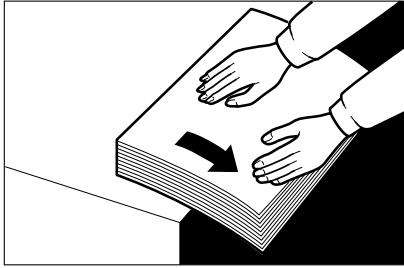

GRCURL0E

- If you cannot correct the paper curl, stack the paper with the curl face down as shown.

5

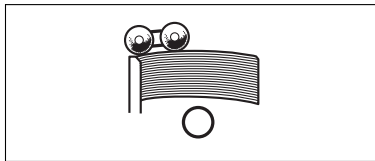

GRMARUSE

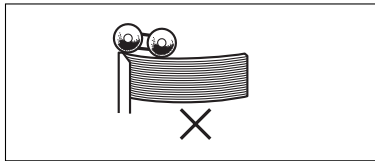

GRBATS0E

What to do If Something Goes Wrong

- When the leading edge margin of the original is less than 5mm, 0.2" or there is a solid image on the leading edge, insert the original with the widest margin first or make a leading edge margin by making a copy.

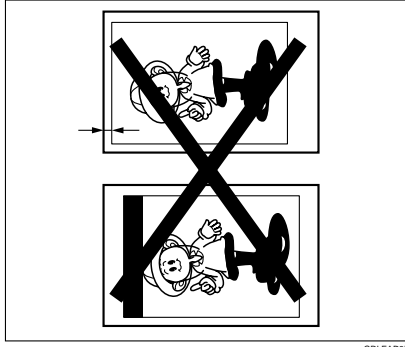

5

“” + “MASTER EJECT JAM. REMOVE JAMMED MASTER”

- 1 Check where the misfed master is. Remove the misfed master as follows.

When a master misfeed occurs in the master eject section

- 1 Pull out the master eject box.

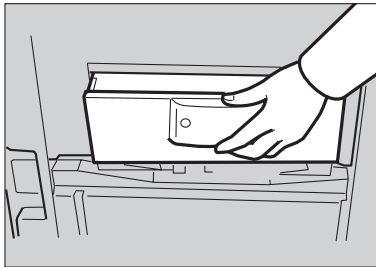

2 Remove the misfed master.

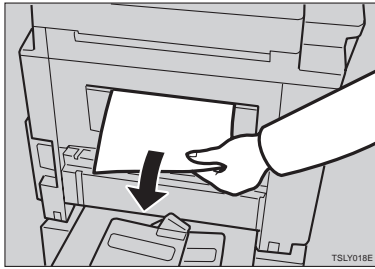

Note

- ❑ Be careful not to stain your hands with ink when you touch used masters.

3 Return the master eject box to its original position.

When a master misfeed occurs on the drum

5

1 Lift the lever to unlock the drum unit and pull out the unit.

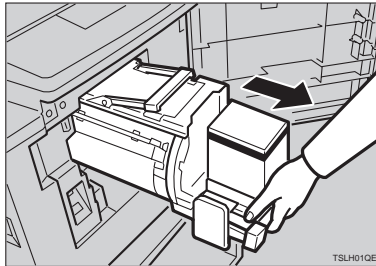

Reference

For how to remove the drum unit, see ⇒ P.52 "Changing the colour Drum Unit".

2 Grasp the drum unit handle and remove the master from the drum.

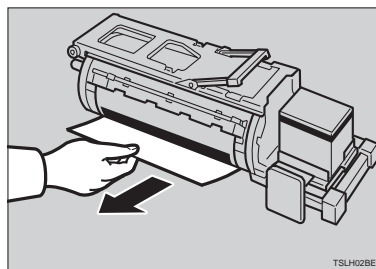

What to do If Something Goes Wrong

3 Pull the master out of the master clamp.

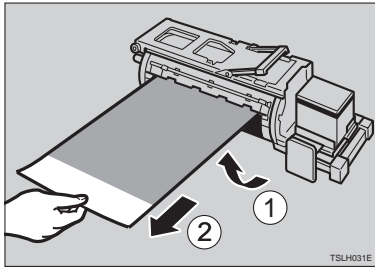

4 Re-insert the drum unit until the drum unit locks in position and put the lever back in place.

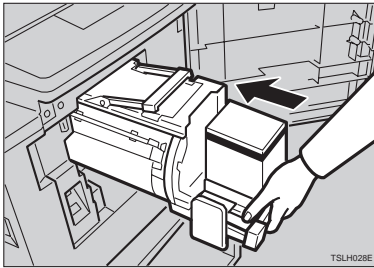

5

“” + “DELIVERY JAM. REMOVE JAMMED PAPER”

1 Remove the misfed paper.

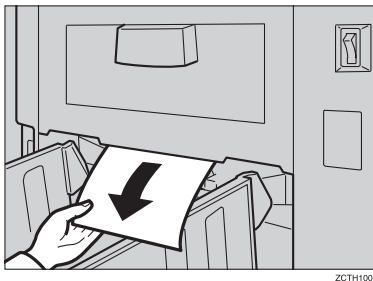

Note

- Make sure that the paper delivery end plate and paper delivery side plates are in the proper position.
- If a jam occurs with the current printing speed, reduce the paper delivery speed.

When the Open Cover/Unit Indicator (☐⚡) Lights

☐⚡ Make sure that the following door/units are closed.

❖ Original Tray

Close the original tray until it locks in position.

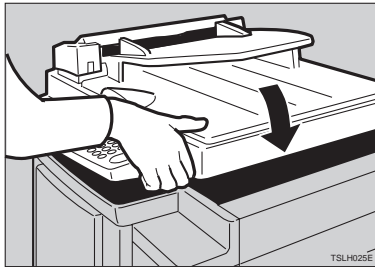

5

❖ Front Door

Close the front door completely.



❖ ADF Unit (Option)

Close the ADF unit until it locks in position.

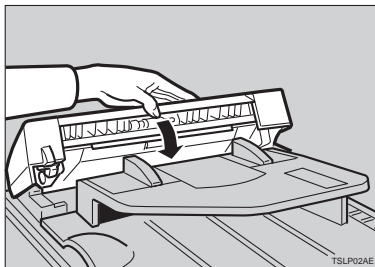

What to do If Something Goes Wrong

Make sure that the drum is completely set in position.

- Set the drum unit completely until it locks in position.

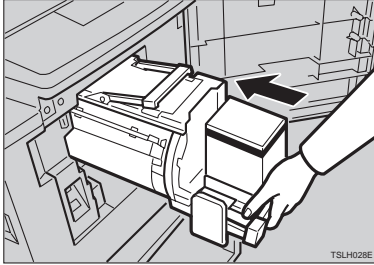

5

When the Master Eject Indicator (🔌) Lights

The **Master Eject** indicator (🔌) and the **Reset** indicator light when it is time to empty master eject box or when you need to set the master eject box.

- 1 Take out the master eject box and remove the used masters.

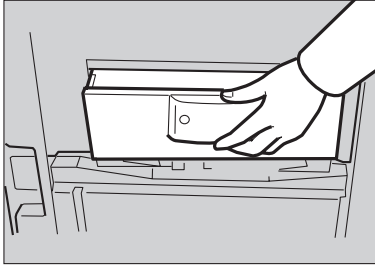

ZCTH110E

 **Note**

- ☐ Spread an old newspaper, then turn the master eject box upside down on it to remove the used masters. Then, throw away the masters.

- 2 Re-install the master eject box. Push in the box until it touches the inside bracket.

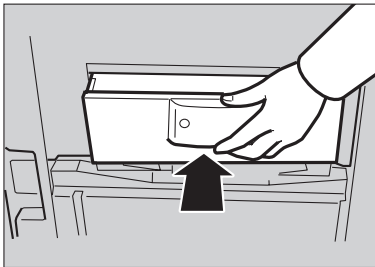

ZCTH120E

5

What to do If Something Goes Wrong

When Other Indicators Light

123

Set the key counter

The key counter (option) is not set. Insert the key counter.

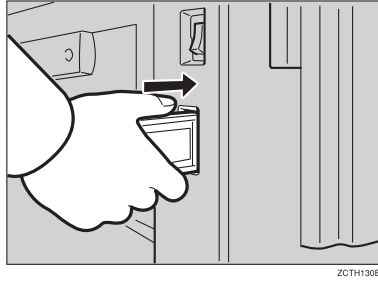

5

When the Prints are Thrown Over the Paper Delivery Tray

- 1 Reduce the printing speed by pressing the [◀] key.

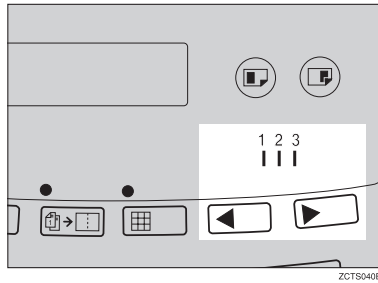

Note

- If a jam occurs with the current printing speed, reduce the paper delivery speed.

What to do If Something Goes Wrong

Poor Printing

Dirt on the Back Side of Paper



Note

- When you use paper smaller than the original, select the proper reduction ratio. Otherwise, you might get dirty background prints.
- When you use postcards and the like, the background might be dirty because postcards do not absorb ink well.
- You might get prints with dirty background when printing at high speed and under high temperature.

5

1 Turn off the main switch.

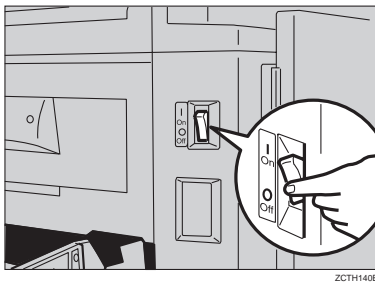

2 Pull out the drum unit.

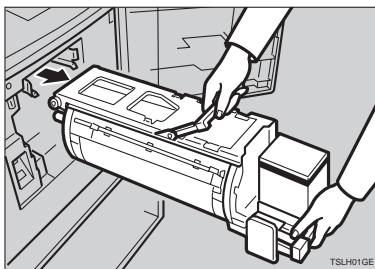

Reference

See ⇒ P.52 "Changing the colour Drum Unit" for the details.

- 3** Clean the pressure roller with a clean cloth.

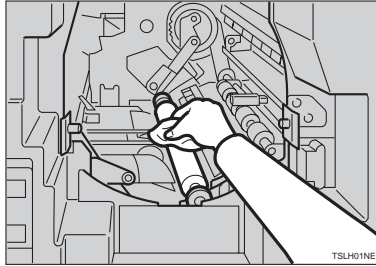

- 4** With a clean cloth, remove any ink that has accumulated on the trailing edge of the drum unit.

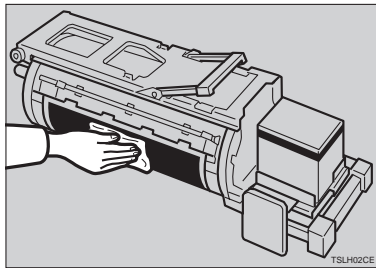

5

- 5** Insert the drum unit until it locks in position, then lower the drum unit lock lever.

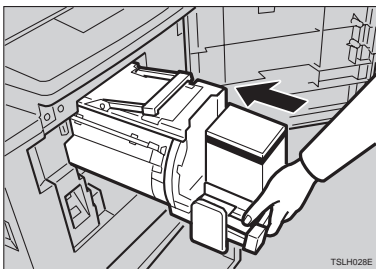

- 6** Close the front door.

What to do If Something Goes Wrong

7 Turn on the main switch.



Dirt on the Front Side of Paper (Black Line/Stain)

5

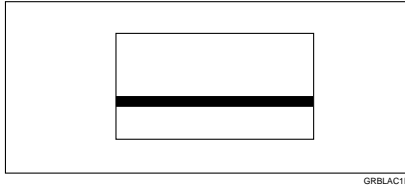

Note

- When black lines or stains still appear on prints even if you clean the above, contact your service representative.
- If there is no margin or if there is a solid image area near the leading edge of the original, make a margin of at least 5mm, 0.2" at the leading edge. Otherwise, the paper exit pawl might become dirty and cause black lines on prints.
- Check the platen cover and clean it if dirty. (See ⇒ P.113 "Platen Cover".)
- Check the exposure glass and clean it if dirty. (See ⇒ P.113 "Exposure Glass".)

White Prints or Incomplete Prints

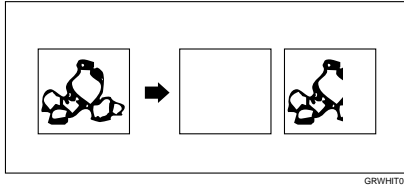

- Make sure that the paper feed side plates touch the paper lightly. Put back the lock lever.

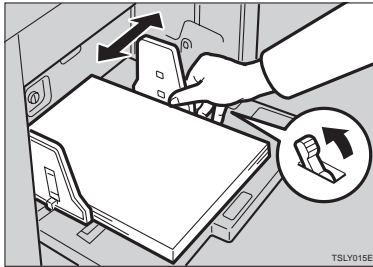

5

- When you use the optional document feeder, make sure that the original guides contact the originals lightly.

When you get white or incomplete prints even if you check the items above, perform the following procedure.

1 Pull out the drum unit.

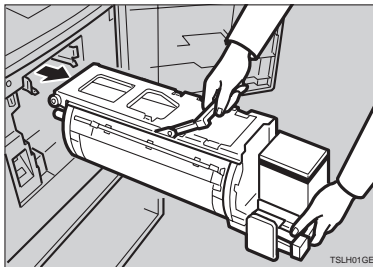

Reference

See ⇒ P.52 "Changing the colour Drum Unit" for the details.

What to do If Something Goes Wrong

2 Remove the master from the drum.

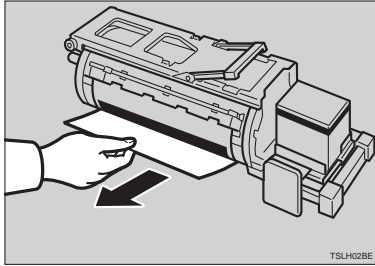

3 Remove paper that is stuck to the drum.

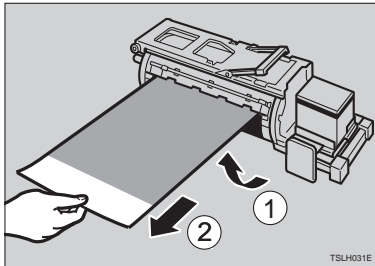

5

4 Insert the drum unit until it locks in position, then lower the drum unit lock lever.

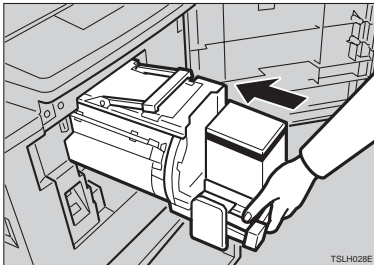

5 Close the front door.

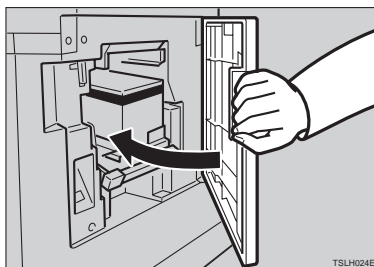

6. Remarks

Operation Notes

General Cautions

- While printing, do not turn off the main switch.
- While printing, do not open the door or covers.
- While printing, do not unplug the power cord.
- While printing, do not move the machine.
- Keep corrosive liquids, such as acid, off the machine.
- Open and close the door and covers softly.
- Do not put anything except originals on the machine.
- Do not spill liquid on the machine.
- When opening or closing the door or covers, keep hold of them so they don't fall.
- When removing the drum unit from the machine, be careful not to let the drum unit fall.
- Do not modify or replace any parts other than the ones specified in this manual.
- Do not operate the machine without covers. You might get your fingers caught in the machine, or the machine might be damaged because, for example, dust or the like might get inside.
- Since some parts of the machine are sharp and might cause injury, touch only the parts specified in this manual.
- If you clean rubber parts with benzine, wipe them with a dry cloth afterwards.
- Always turn the machine off when you have finished printing for the day.
- If the machine must be transported by vehicle, please contact your service representative.
- Make sure to make a few trial prints to check the image position because the image position of the trial print might not correspond with that of the original.
- If the image registration is not consistent, slow the printing speed down to Setting 1.
- When performing duplex or multicoloured printing, leave the printed paper for a while before the next printing in order to let the ink dry on the printed paper. If this is not done, feed roller marks will appear on the print image.

 Remarks

- If the machine is not used for a long period, the image density might decrease because the ink on the drum might dry. Make extra prints until the image density recovers.
- When the machine is used in low temperature conditions, the image density might decrease. In this case, slow the printing speed down to step 1 or 2.
- When making duplex prints, misdetection of paper wrapping might occur if the paper delivery sensor detects a black area at the leading edge of the back side. Keep at least an 5mm, 0.2" margin at the leading edge of the back side of the printing paper.
- Press the **[Proof]** key to perform a test print as the first few prints might be light.
- The top sheet might remain between the feed rollers when you press the **[Paste Shadow Erase]** key. In this case, remove the top sheet.
- When making duplex prints or when using non-white printing paper, the paper end sensor might malfunction and fail to detect the paper. In this case, place a blank sheet under the printing paper on the paper feed tray.
- The outer portion of the image might not be printed under low temperature. In this case, slow the printing speed down to step 1 or 2, or increase the room temperature.
- The paper exit pawl might contact the printing paper and cause black lines on the prints. In this case, increase the printing speed or make a new master with lighter image density mode.
- If you cannot pull out the drum, close the front cover again to rotate the drum. Pull out the drum after it stopped at the position.
- The leading edge of the prints might become stained if the edge touches the image of prints on the paper delivery tray.
- The ink of the print on the paper delivery tray might stick to the back side of the next print.
- When the machine is on and the power source is less than 90 % of the specified amount, printing quality will decrease. Therefore, make sure the supply from your electrical outlet is at least 90 % of the required amount.
- As various kinds and qualities of paper exist, some paper might be wrapped around the drum or cause misfeeds.
- If your hands are stained with ink:
 - Avoid prolonged or repeated contact with skin.
 - Cleanse skin thoroughly after contact, before breaks and meals, and at the end of the work period.
 - Ink is readily removed from skin by waterless hand cleaners followed by washing with soap and water.
- Also, be careful not to get any ink on your clothing while emptying the master eject box or while loading a new ink cartridge.

- The image density varies according to the printing speed and the room temperature. So, adjust the printing speed or increase the room temperature.
- When you make a lot of prints from a small image, ink might ooze out from the edges of the master, especially under high temperature and when printing in two or more colours. In this case, make a new master.
- Use ink made within one year. Ink stored for a long period tends to dry slowly and yield lower image density.
- While making a master, do not leave the platen cover or optional document feeder open.
- In Letter/Photo mode, moire patterns might occur when screened originals are printed. In this case, make prints in Letter or Photo mode.
- When you use originals with light lettering, edges of the letters might be printed clearly and the inside of the letters might be light. In this case, increase the image density.
- When marks on the printing paper occur, clean the paper feed roller. ⇒ P.113 *"Paper Feed Roller (paper feed tray)"*
- If you make a print before the ink on the first print dries, the ink may adhere to the paper feed roller and soil the print. Before printing on the reverse side of a printed sheet or overprinting on a printed sheet, be sure that the ink on the first print is adequately dry. ⇒ P.113 *"Paper Feed Roller (paper feed tray)"*

6

Print Paper

- When the paper is curled, stack the paper with the curl face down, otherwise the paper might wrap around the drum or stains might appear.
- Postcards and the like do not absorb ink well. Offset images might appear on the rear side of subsequent prints. Solid image originals will cause offset image prints.

Originals

- If there is no margin or if there is a solid image area near the leading edge of the original, make at least a 5mm, 0.2", margin at the leading edge; otherwise, the paper might wrap around the drum or the paper exit pawl might become dirty and cause black lines on prints.
- If you use originals that have bold letters or solid images at the leading edges, you might get prints with dirty edges. In this case, insert the widest margin first, or raise the printing speed.
- If you use paste-up originals, select Paste Shadow Erase mode (see ⇒ P.22 *"Paste Shadow Erase—Erasing the Shadow of Pasted Originals"*) make sure that the pasted parts hold firmly to the base sheet. If the thickness of the paste-up originals is more than 0.1mm and the space between the pasted parts is less than 2mm, 0.08", a shadow might appear on the print.

Remarks

- Under the following conditions, the machine might not detect the original on the exposure glass. If you press the **[Start]** key again, the machine will start making a master anyway:
 - When you set a dark original on the exposure glass.
 - When the original is not centred according to the size marks on the right scale.
 - If you do not open the platen cover at an angle of more than 25 degrees with the exposure glass when you replace originals.
 - If the machine is installed under a strong light.

6

110

Where to Put Your Machine

Your machine's location should be carefully chosen because environmental conditions greatly affect its performance.

Environmental Conditions

Optimum environmental conditions

⚠ CAUTION:

- *Keep the equipment away from humidity and dust. Otherwise a fire or an electric shock might occur.*
- *Do not place the equipment on an unstable or tilted surface. If it topples over, it could cause injury.*

⚠ CAUTION:

- *If you use the equipment in a confined space, make sure there is a continuous air turnover.*

⚠ CAUTION:

- *After you move the equipment, use the caster fixture to fix it in place. Otherwise the equipment might move or come down to cause a personal injury.*

- Temperature: 10 – 30 °C, 50 – 86 °F
- Humidity:
 - Main Frame: 20 – 90 % RH
 - Document feeder (option): 20 – 70 % RH
- A strong and level base (a sturdy desk and cabinet etc.).
- The machine must be level within 5mm, 0.2" both front to rear and left to right.
- Make sure to locate this machine in a large well ventilated room that has an air turnover of more than 30 m³/hr/person.

Environments to avoid

- Locations exposed to direct sunlight or strong light (more than 1500 lux).
- Locations directly exposed to cool air from an air conditioner or heated air from a heater. (Sudden temperature changes might cause condensation within the machine.)
- Places where the machine might be subjected to frequent strong vibration.
- Dusty areas.
- Areas with corrosive gases.

Remarks

Power Connection

⚠ WARNING:

- **Only connect the machine to the power source described on the inside front cover of this manual. Connect the power cord directly into a wall outlet and do not use an extension cord.**
- **Do not damage, break or make any modifications to the power cord. Do not place heavy objects on it. Do not pull it hard nor bend it more than necessary. These actions could cause an electric shock or fire.**

⚠ CAUTION:

- *Unplug the power cord from the wall outlet before you move the equipment. While moving the equipment, you should take care that the power cord will not be damaged under the equipment.*

⚠ CAUTION:

- *When you disconnect the power plug from the wall outlet, always pull the plug (not the cable).*

6

◆ Main Frame

- Make sure the plug is firmly inserted in the outlet.

Access to Machine

Place the machine near the power source, providing clearance as shown.

◆ Main Frame

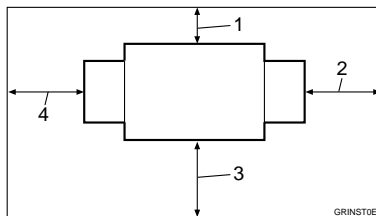

1. More than 20 cm, 8.0"
2. More than 60 cm, 23.7"
3. More than 60 cm, 23.7"
4. More than 60 cm, 23.7"

Maintaining Your Machine

To maintain high print quality, clean the following parts and units regularly.

Main Frame

Exposure Glass

- 1** Lift the platen cover or document feeder.
- 2** Clean the exposure glass with a damp cloth and wipe it with a dry cloth.

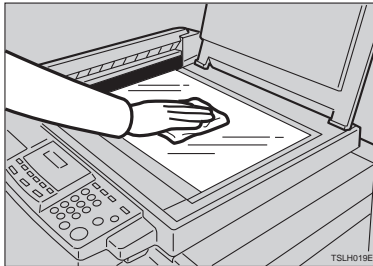

Note

- If you do not clean the exposure glass, marks on the glass will be printed.

Platen Cover

- 1** Lift the platen cover.
- 2** Clean the platen cover with a damp cloth and wipe it with a dry cloth.

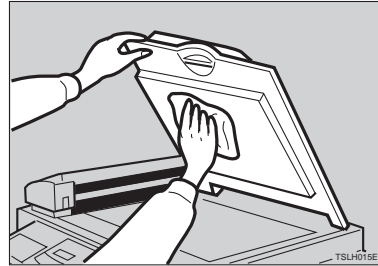

Note

- If you do not clean the platen cover, marks on the cover will be printed.

Paper Feed Roller (paper feed tray)

- 1** Wipe off the paper dust on the paper feed roller with a damp cloth, then wipe it with a dry cloth.

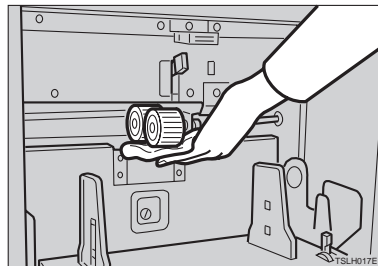

Note

- If you do not clean the paper feed roller, paper misfeeds tend to occur.

Remarks

Optional Document Feeder

Separation Roller

- 1** Open the ADF unit.
- 2** Clean the separation roller with a damp cloth and wipe it with a dry cloth.

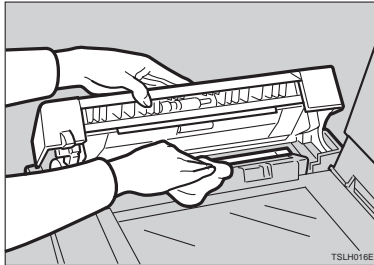

6

Note

- If you do not clean the separation roller, original misfeeds tend to occur.

Combination Chart

This combination chart shows which modes can be used together.

○	means that these modes can be used together.
×	means that these modes cannot be used together.

		1	2	3	4	5	6	7	8	9	10	11	12	13	14
1	Reduction	--	×	○	○	○	○	○	○	○	×	○	○	○	○
2	Enlargement	×	--	○	○	○	○	○	○	○	×	○	○	○	○
3	Auto Cycle	○	○	--	○	○	○	○	○	○	○	○	○	○	○
4	Memory mode	○	○	○	--	×	○	○	○	○	×	×	○	○	○
5	Class mode	○	○	○	×	--	○	○	○	○	×	×	○	○	○
6	Combine Copies	○	○	○	○	○	--	○	○	○	×	×	○	○	○
7	Centre/Edge Erase	○	○	○	○	○	○	--	○	○	×	○	○	○	○
8	Type of Original	○	○	○	○	○	○	○	--	○	×	○	○	×	○
9	Image Density	○	○	○	○	○	○	○	○	--	×	○	○	○	○
10	On-Line	×	×	○	×	×	×	×	×	×	--	○	○	×	×
11	Overlay	○	○	○	×	×	×	○	○	○	○	--	○	×	×
12	Economy mode	○	○	○	○	○	○	○	○	○	○	○	--	×	○
13	Tint mode	○	○	○	○	○	○	○	×	○	×	×	×	--	○
14	Fine mode	○	○	○	○	○	○	○	○	○	×	×	○	○	--

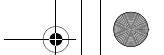

Remarks _____

6

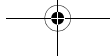
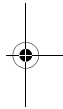
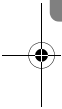

7. Specification

Main Frame

- ❖ **Configuration:**
Desk top
- ❖ **Printing Process:**
Full automatic one drum system
- ❖ **Original Type:**
Sheet/Book
- ❖ **Original Size:**
Maximum 257mm × 364mm, 10.2" × 14.4"
- ❖ **Pixel Density:**
300dpi (in Fine mode 400dpi)
- ❖ **Image Mode:**
Photo mode (Sand pattern)
Letter mode (Standard mode)
Letter/Photo mode
- ❖ **Reduction Ratios:**
 - Inch version:
93 %, 77 %, 74 %, 65 %
 - Metric version:
93 %, 87 %, 82 %, 71 %
- ❖ **Enlargement Ratios:**
 - Inch version:
155 %, 129 %, 121 %
 - Metric version:
141 %, 122 %, 115 %
- ❖ **Printing Area:**
 - LG drum:
More than 210mm × 355mm, 8.2" × 14.0"
 - A4 drum:
More than 210mm × 288mm, 8.2" × 11.3"
 - B4 drum:
More than 250mm × 355mm, 9.8" × 14.0"

Specification

❖ **Printing Paper Size:**

Maximum 268mm × 388mm, 10.5" × 15.2"

Minimum 90mm × 148mm, 3.6" × 5.9"

❖ **Leading Edge Margin:**

5mm ± 3mm, 0.2" ± 0.12"

❖ **Print Paper Weight:**

47.1g/m² to 209.3g/m², 12.5 lb to 55.6 lb

❖ **Print Speed:**

80 – 130rpm (3 steps)

❖ **First Copy Time (Master Process Time):**

Less than 29.0 seconds (A4☐, 8¹/₂" × 11"☐)

(When setting an original on the exposure glass)

❖ **Second Copy Time (First Print Time):**

Less than 31.0 seconds (A4☐, 8¹/₂" × 11"☐)

(When setting an original on the exposure glass)

❖ **Colour Printing:**

Drum unit replacement system (black, red, blue, green, brown, yellow, purple, navy, maroon, orange, teal and gray)

❖ **Image Position Adjustment:**

- Vertical:
More than + 10mm, - 10mm, + 0.39", - 0.39"
- Side:
10mm, 0.39" (for either side)

❖ **Paper Feed Tray Capacity:**

1,000 sheets (80g/m², 20 lb)

❖ **Paper Delivery Tray Capacity:**

1,000 sheets (80g/m², 20 lb)

❖ **Master Eject Box Capacity:**

70 masters

❖ Dimensions (W × D × H):

	Width	Depth	Height
Stored	607mm, 23.9"	651mm, 32.6"	567mm, 22.4"
Stored with document feeder	607mm, 23.9"	651mm, 32.6"	617mm, 24.3"
Set up	1,187mm, 46.8"	651mm, 32.6"	567mm, 22.4"
Set up with document feeder	1,187mm, 46.8"	651mm, 32.6"	617mm, 24.3"

❖ Weight:

- Main Frame: 65kg, 143.3 lb
- Main Frame with optional document feeder: 68kg, 150.0 lb

❖ Noise Emission *1:

Sound Power Level

	Printing Speed	Noise Emission
During printing	80cpm	81dB(A)
	100cpm	82dB(A)
	130cpm	83dB(A)
Stand-by	--	48dB(A)

Sound Pressure Level*2

	Printing Speed	Noise Emission
During printing	80cpm	71dB(A)
	100cpm	72dB(A)
	130cpm	72dB(A)
Stand-by	--	35dB(A)

*1 The above measurement made in accordance with ISO 7779 are actual value.

*2 It is measured at the position of the operator.

❖ Power Source:

See the inside front cover of this manual.

Specification

❖ **Power Consumption:**

Stand-by	Less than 0.01kW
Master Making	Less than 0.24kW
Printing: Speed 1	Less than 0.14kW
Printing: Speed 2	Less than 0.16kW
Printing: Speed 3	Less than 0.20kW

❖ **Optional Equipment:**

- Colour Drum
 LG Drum
 A4 Drum
 B4 Drum
- Key Counter
- Tape Dispenser
- 30 Originals Document Feeder

30 Originals Document Feeder

❖ Original Type:

Sheet

❖ Original Weight:

- When setting a stack of originals:
50 – 90g/m², 13.3 – 23.9 lb
- When setting one sheet at a time:
40 – 120g/m², 10.6 – 31.9 lb

❖ Original Size:

Max. 257mm × 364mm, 10.2" × 14.4"
Min. 148mm × 105mm, 5.8" × 4.1"

❖ First Copy Time (Master Process Time):

Less than 34 seconds (A4☐, 8¹/₂" × 11"☐)

❖ Second Copy Time (First Print Time):

Less than 36 seconds (A4☐, 8¹/₂" × 11"☐)

❖ Original Capacity:

30 sheets (80g/m², 20 lb)

Note

- Specifications are subject to change without notice.

Specification

Consumables

Name	Size	Remarks
Master for LG drum	Length: 125m, 410ft/roll Width: 240mm, 9.5" 2 Rolls/case	260 masters can be made per roll
Master for A4 drum	Length: 125m, 410ft/roll Width: 240mm, 9.5" 2 Rolls/case	300 masters can be made per roll
Master for B4 drum	Length: 125m, 410ft/roll Width: 280mm, 11.0" 2 Rolls/case	260 masters can be made per roll
Ink-Black	600ml/pack, 5 packs/case	Environmental conditions: - 5 to 40°C, 10 to 95 % RH
Ink-Red	600ml/pack, 5 packs/case	
Ink-Blue	600ml/pack, 5 packs/case	
Ink-Green	600ml/pack, 5 packs/case	
Ink-Brown	600ml/pack, 5 packs/case	
Ink-Yellow	600ml/pack, 5 packs/case	
Ink-Purple	600ml/pack, 5 packs/case	
Ink-Navy	600ml/pack, 5 packs/case	
Ink-Maroon	600ml/pack, 5 packs/case	
Ink-Orange	600ml/pack, 5 packs/case	
Ink-Teal	600ml/pack, 5 packs/case	
Ink-Gray	600ml/pack, 5 packs/case	
Tape for Tape dispenser	35m (114.8ft)/roll	

 **Note**

- Specifications are subject to change without notice.

INDEX

A

Accessing Service Programs, 57
 Access to machine, 112
 ADF unit, 43
 ADF unit open lever, 43
 Adjusting the Print Image Density, 11
 Adjusting the Print Image Position, 9
 After clearing misfeeds, 84
 Auto Cycle, 26
[Auto Cycle] key, xi, 26

B

Behind cover, vii

C

[Center/Edge Erase] key, x, 18, 20
 Centre/Edge Erase, 18
 Changing the colour Drum Unit, 52
 Changing the Paper Size, 74
 Changing the Printing Speed, 14
 Changing the Settings of
 Service Programs, 58
 Check Indicator, x
 Class Mode, 28
 Clearing Misfeeds, 84
[Clear Modes/Energy Saver] key, xi
[Clear/Stop] key, xi, 15
 Colour Printing, 52
 Combination Chart, 115
 Combine, 33
 Combine Copies with the
 Document Feeder, 46
[Combine] key, x, 33
 Consumables, 122
 Counter, xii

D

Dirt on the Back Side of Paper, 102
 Dirt on the Front Side of Paper
 (Black Line/Stain), 104
 Document Feeder, 43
 Document feeder, viii
 Document Feeder Exterior, 43
 Drum unit, viii
 Drum unit lock lever, viii

E

Economy Mode, 25
 Edge Erase, 20
[Enlarge] key, x, 17
 Enlargement, 16
[Enter] key, xi
 Environments to avoid, 111
 Error indicators, xii
 Exposure Glass, 113
 (E-XX), 83

F

Feed roller pressure lever, vii
[Fine] key, xi, 13
 Fine Mode, 13
 Front door, vii
[Full Size] key, x

G

Guidance display, xii

H

How to Check the Total Number of Masters
 and Prints Made Under All User Codes, 70
 How to Check the User Code Counter, 68
 How to Clear the User Code Counter, 69
 How to Clear the User Code Total Counter, 71
 How to Set User Code Mode, 66
 How to Use User Code Mode, 67

I

[Image Density] key, x, 11
[Image Position] key, xi, 9
 Ink holder, viii

L

Loading Paper, 3
 Loading Paper on the Paper Feed Tray, 73

M

Machine Interior, viii
 Main Frame, 113, 117
 Main switch, viii
 Maintaining Your Machine, 113
 Making Colour Prints, 52

Master Eject Indicator, 99
 Master Roll Replacement, 77
 Memory/Class indicator, xii
【Memory/Class】 key, xi, 28, 30
 Memory Mode, 30
 misfeed indicator, 81

N

Number keys, xi

O

open cover/unit indicator, 81
 Operation Notes, 107
 Operation Panel, x
 Operation panel, vii
 Optimum environmental conditions, 111
 Options, ix
 Original guides, 43
 Originals, 2, 44
 Original tray, 43
 Original tray release lever, vii

P

Paper delivery end plate, viii
 Paper delivery side plates, viii
 Paper delivery tray, viii
 Paper Feed Roller, 113
 Paper feed side plates, vii
 Paper feed tray, vii
 Paper feed tray down key, vii
 Paste Shadow Erase, 22
【Paste Shadow Erase】 key, x, 22
 Photo mode, 24
 Placing a New Roll of Tape in the
 Tape Dispenser, 79
 Platen Cover, 113
 Platen cover, vii
 Poor Printing, 102
 Power connection, 112
 Preparation for Printing, 3
 Preset Reduce/Enlarge, 16
 Printing in Two colours, 54
 Printing Paper, 1
【Print】 key, xi
 Program, 38
【Program】 key, xi, 38
【Proof】 key, xi
 Protecting a Program, 40

R

Recalling a Program, 39
【Reduce】 key, x, 17
 Reduction, 16
 Removing Program Protection, 41
 Replenishing Paper, 73
 Restoring Paper Feed and Paper
 Delivery Trays, 7

S

Safety Information, i
【Scroll】 key, x
【Security】 key, x, 42
 Security Mode, 42
 Separation Roller, 114
 Service Program Menu, 59
 Setting Up the Paper Delivery Tray, 4
 Shifting the Image Position Forward
 or Backward, 9
 Shifting the print image to the left, 10
 Shifting the print image to the right, 10
 side plate fine adjusting dial, 9
 Side tray fine adjusting dial, vii
【Skip Feed】 key, x, 37
 Skip Feed Printing, 37
 Speed indicators, xii
【Speed】 key, xi
 Standard Printing, 5
【Start】 key, xi
 Stop the Machine, 15
 Storing Your Settings, 38
 supply/exchange indicators, 81

T

tape dispenser, 79
 Thin paper, 23
【Tint/Economy】 key, x, 12, 25
 Tint Mode, 12
【Type of Original】, 24
【Type of Original】 key, x

U

User Codes, 66

W

When the Add Ink Indicator (▲) Lights, 75
 Where to Put Your Machine, 111
 White Prints or Incomplete Prints, 105
【◀】 or **【▶】** key, 14